

**REF**

56-270

56-270-CS

56-270/100-CS

56-270-CS-UK

56-270/LOW-CS

# EASY SoftBack

User Manual

Technical Manual

Service Manual



**SWL: 150 kg/ 330 lbs**

# EASY SoftBack

EASY is a well-designed Hygiene Chair with a great many advanced functions. The Hygiene Chair is designed with telescoping pillars to create as much space and flexibility as possible for care personnel. The Chair is suitable for use in shower and toilet environments in care institutions and at home.

EASY can be raised, lowered and tilted forwards and backwards even with the user in the Chair. It's functions make the EASY Unequaled aid for personnel while also providing great comfort for the user (for example, its ability to tilt really helps take the strain).

EASY is available with our new, soft Comfort seat with an opening at the rear for a more natural, hygienic working method.

## Contents

1. Intended Use	03
2. Contraindications, Precautions and Warnings	03
3. Changing Seat Height and Tilt Angle	06
4. Battery Charging	07
5. Battery On/Off	07
6. Driving the Chair	07
7. Adjusting the Neck Support	07
8. Backstrap	07
9. Armrest Lock	08
10. Installing Seat with the Rear Opening (Accessory).	08
11. Sanitary Pan	08
12. Footrest/Heel Restraint	08
13. Castors	08
14. Calibrating the Actuators	08
15. Reset Service Indicator	09
16. Cleaning	09
17. Troubleshooting when the Chair is Inoperable	09
18. Replacement of Remote Control	10
19. Recycling/Disposal	10
20. Warranty	10
21. Maintenance	11
22. Technical Specification	11
23. Dimensions	13
24. Information on EMC	14
25. Further Information om EMC, Advanced	14
26. Parts List	17
27. Spare Parts	17
28. Accessories	19
29. Table of Symbols	19

## 1. Intended Use

The Hygiene chair allows the user physical support during showering, washing, drying and dressing in safe and comfortable seated position. Hygiene chair and accessories are intended to be used in dry and wet rooms (not immersed in water), in Home Healthcare environment and Professional Healthcare facility environment.

## 2. Contraindications, Precautions and Warnings

We hope our product meets or exceeds your expectations. These Instructions for Use contain the information users of the product need to know for its safe operation. In addition to the instructions for use, there is a technical manual that describes the chair's structure and which includes information of a more technical nature and a spare parts list.

READ THESE INSTRUCTIONS FOR USE BEFORE USING THE PRODUCT.

The Hygiene Chair has a fixed battery that is charged via a connection in the remote control. The time required for a discharged battery to reach an 80% charge is around 12 hours. The remote control has a charging indicator that will show whether or not the battery needs to be charged. Make a habit of always charging the battery if at the end of the day it has dropped to level 1 (one green bar on the battery indicator). If the Hygiene Chair will not be used for a few days, we recommend switching off the battery by means of the Off button located on the battery.

The Hygiene Chair also has a service indicator that lights up after around 11 months' operation as a reminder regarding the scheduled service that must be carried out at least once per year. Information about how to reset the service indicator can be found in the technical manual.

The Hygiene Chair has a number of functions to enhance safety. When tilting forward or back, the chair will always stop when the horizontal position is reached. The chair cannot be tilted forward if the seat height is greater than 65cm. In order to raise the chair higher than 65cm, the seat must be horizontal or tilted to the rear. It is not possible to use the chair while charging the battery.

Users will experience a soft start of around 5 seconds when the chair is raised or lowered. This is normal and takes place in order to synchronize the two height adjustment actuators.

The Hygiene Chair is raised and lowered through telescopic pillars with built-in motors. The pillars have an open design which allows water and dirt to run through internally. When necessary, clean the pillars and the bottom surfaces with cleaning agent. The cleaning agents dissolve dirt and grease and break down any organic substances. Rinse with water. Note that the pillar base plates are accessible for mechanical cleaning.

Bear in mind the crush risk that is always present when hands and feet get in the way of chair movement, especially when tilting forward or when the chair is lowered to its lowest level. Depending on the setting, the foot rest may touch the floor or the chair frame.

Before you begin using your chair, the battery must be activated. Do this by pressing the battery ON button (see section in these instructions for use).

**Contraindications**

The Hygiene Chair may not be used by patients above the maximum weight indicated on the labels and in this manual.

The tilt mechanism should only be operated by the caregiver.

The chair is not designed to be used as seating for extended periods.

This Hygiene Chair is designed for indoor use on level surfaces and in wet spaces.

**Precautions**

The caregiver must be able to read and understand the IFU of the product. This IFU should be available to the caregiver at all times.

Check the charging cable is not plugged in, prior to use. It is not possible to operate the chair while charging the battery.

Make sure the remote control socket/charge is always covered/plugged in when using the chair. Otherwise water may get in and damage the remote control.

Emergency lowering: if battery charge is insufficient for chair operation or if the proximity sensor on the height adjustment actuator is defective, the Emergency lowering button must be used (see manual; section 3).

Check the condition of snap locks and castors frequently, keep them free of hair and soap deposits, etc.

Keep fingers away from the armrest joints to avoid pinching during raising and lowering.

To avoid injury, do not insert fingers or toes into the drainage holes in the backrest or foot rests.

Check the Hygiene Chair is correctly mounted/assembled before its first use, after every folding/disassembly and after any transport.

Check the battery status prior to and after each use.

It is important to never leave the user alone during the transfer.

Only transfer the user from or to the chair when the seat frame and backrest are set in an upright position.

Inspect the Hygiene Chair once per year to detect any signs of damage. Check that the hand control does not show signs of wear.

Check the tilting motion and inspect the actuators full range regularly.

Handle the battery with care. Do not drop. Use only batteries and cables that are intended for the hygiene chair.

Activate the brakes whenever the hygiene chair is not in use.

Avoid placing / using the chair less than 0.35m from other medical equipment and / or mobile phones (or other transmitting equipment).

Do not store the chair in direct sunlight as the black surface may become hot and uncomfortable for the user.

Charging the battery should always be done in a dry area to avoid dangerous situations with electricity and wet areas.

The chair should be pulled backwards over thresholds. For optimal caregiver ergonomics, the handlebars should be at elbow height.

Always use the chair with armrests in place (folded down). Armrests (and footrests, if present) should only be flipped up during transfer to and from the chair.

Insert or remove the sanitary pan/bucket when the chair is not in use.

The product can be raised, lowered, or tilted with the aid of encapsulated, concealed electronics. The product may thus NOT be immersed or used under water.

The product may not be used in a sauna or cleaned with steam.

**Warnings**

Do not use the chair when defective or malfunctioning.

All castor locks are foot-operated. – Do not operate the castor locks by hand.

Never stand on the foot supports as there is a risk of tipping.

The battery can be damaged if not charged at least every 14 days in the “On” position or at least every three months in the “Off” position.

Make sure protective covers are always put back in place after cleaning activities.

Always replace the Hygiene Chair’s electrical components or cabling with original parts from supplier. Failure to do so may affect the product’s EMC approval.

The product must be repaired by a qualified technician. Damaged parts must be replaced by a qualified technician.

Warranty applies only if repairs or alterations are made by personnel who are authorized by Direct Healthcare Group.

### 3. Changing Seat Height and Tilt Angle

Normal up/down; Rapid up/down. NOTE! The seat has a soft start for around 5 sec. before the correct speed is achieved. Make sure the footrest does not touch the floor when the seat is at lower levels – this can happen if the footrest is set for a tall user.

Tilting forwards/rearwards: The chair can be tilted 5 degrees forwards\* and 30 degrees rearwards. When tilting, the chair will always stop at the horizontal position. Thus to continue tilting forwards or rearwards, the forwards/rearwards button must be pressed again. When tilting forwards, make sure the footrest does not touch the floor or frame – this can happen if the footrest is set for a tall user.

(\*In certain markets, the chair can be tilted further to 6 degrees forwards.  
Note: Crush risk if this is done.)

Emergency lowering: if battery charge is insufficient for chair operation or if the proximity sensor on the height adjustment actuator is defective, the Emergency lowering button must be used. Upon activation, the chair will revert to the horizontal position and then to the lowest seat height. Exercise caution when activating as the system safety sensors are bypassed. In particular, make sure the chair proceeds evenly to its minimum height to prevent skewing.

Service indicator – the lamp will flash at 4 sec. intervals when actual operating time reaches 11 months from the last reset. After 12 months, the lamp will remain on. This indicates the need for scheduled maintenance (page 8). Resetting the service indicator – see technical manual.

Battery indicator – shows current battery status; 3 bars indicate full charge. When a single bar shows, the chair should be charged that same day. When a red bar shows, stop using the chair and charge the battery. Make a habit of always charging the battery if at the end of the day it has dropped to level 1 (one green bar on the battery indicator). If the Hygiene Chair will not be used for a few days, we recommend switching off the battery by means of the Off button located on the battery.

NOTE: The battery can be damaged if not charged at least every 14 days in the On position or at least every three months in the Off position.

The remote control enters sleep mode 30 sec. after the last activation.

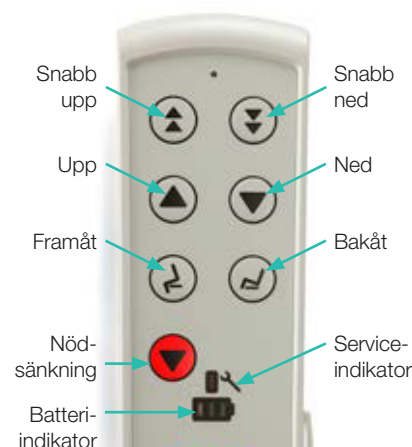

## 4. Battery Charging

Charge the battery by connecting the charger supplied to a wall socket and the remote control connector. A discharged battery takes around 12 hours to charge to 80% and 24 hours to reach 100% charge. While the battery is charging, the battery indicator will flash showing actual charge level. All three bars will show a constant green light when the battery is fully charged. We recommend the battery always be charged to at least 80% – once begun, charging should not be interrupted before an 80% charge is achieved.

NOTE: The battery can be damaged if not charged at least every 14 days in the On position or at least every three months in the Off position.

For safety reasons, chair electronics cannot be used while the battery is charging. Avoid charging in wet spaces. Make a habit of always charging the battery if at the end of the day it has dropped to level 1 (one green bar on the battery indicator). If the Hygiene Chair will not be used for a few days, we recommend switching off the battery by means of the Off button located on the battery

Make sure the remote control socket/charge is always covered plugged in when using the chair. Otherwise water may get in and damage the remote control.



## 5. Battery On/Off

The battery is located under a protective cover at the base of the chair. The battery has On/Off buttons that are reached through an opening at the lower front part of the chair. Operate the buttons by pressing them with a pointed object (not sharp). When delivered, the battery is switched off. Activate the battery by pressing the On button or connecting the charger to the remote control. To one side of the buttons, there is also an LED indicator that shows battery charge.



## 6. Driving the Chair

We recommend using the handlebar whenever the chair must be moved (with/without a patient). The handlebar is designed so that the chair can be moved forwards and turned easily and with the use of little force.

## 7. Adjusting the Neck Support

The neck support has many degrees of freedom and can be fixed vertically, horizontally and radially in order to achieve the very best comfort for the patient.

- The neck support holder can be moved sideways (requires Allen key).
- Up/down – locked using a lever on the neck support holder
- Forward/back – locked by associated lever on the neck support.
- The pad can be set and locked in the desired position with a star handle.



## 8. Backstrap

The back strap can be set to the preferred tension using the 3 buckles on the back. The back strap has a notch on each side of the armrest intended for the installation of accessories.





## 9. Armrest Lock

The armrest is locked in the extended position. To lift the armrest, pull out the pin and raise the armrest.



## 10. Installing Seat with the Rear Opening (Accessory)

The seat comprises two halves that are snapped in place with the aid of clamps on the seat's underside.

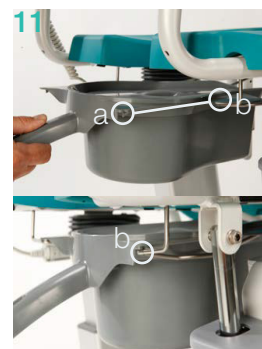

## 11. Sanitary Pan

The sanitary pan is slid into position from behind between the seat and wire guides as shown in fig. 11. Make sure the sanitary pan is slid into position above the wire guides. Also make sure that the pan assumes the right position in relation to the cutout/seat and that the pan's rear hook locks into the guide.

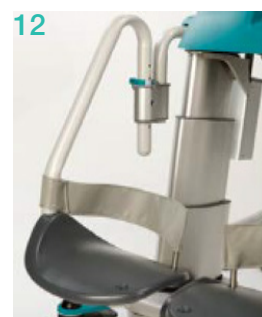

## 12. Footrest/Heel Restraint

The foot rest can be easily set to the preferred height, swung aside (lift/swing) or removed (lift away). Set footrest height by moving the green clip to the preferred hole.

## 13. Castors

The Easy Hygiene Chair can feature 2 different types of wheels. The images show the options.

A) Single wheel 125mm

The Hygiene Chair has 4 wheels (full brakes). The wheel on the right-hand front side (grey brake pad) also features a directional lock.

B) Double wheel, 100mm

The Hygiene Chair has 4 wheels, of which the one on the righthand front side features a directional lock and the other 3 are fitted with full brakes.

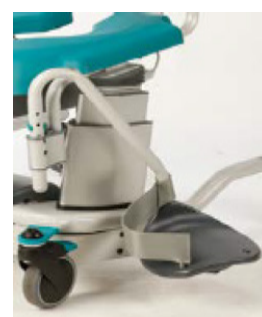

When the directional lock is activated, wheels cannot be turned. This is particularly useful when moving heavier patients. The chair is thus significantly easier for staff to push and control. The directional lock should be released when manoeuvring in tight spaces. The other wheels (x 3)/green brake pad are conventional wheels that lock both directionally and rotationally when the brakes are applied.



## 14. Calibrating the Actuators

The calibration of the actuators (height / lowering only) is normally done fully automatically each time the chair reaches its end positions (min height, max tilt).

If the chair still does not go in parallel or if the tilt function does not seem to work, an ACTIVE calibration can be done. This is done by holding down <button-slow / up> + <button-slow / down> simultaneously.

After about 15 seconds the chair will be moved to its end positions ie. min height and maximum slope backwards. Hold down the buttons until the end positions are reached. Release the buttons and wait 5 seconds. The chair is now calibrated and can be used again. Calibration should NOT be done with user in chair. Note that all 3 actuators move during the calibration phase. Otherwise, cancel the calibration immediately and contact Customer Service.





## 15. Reset Service Indicator

The remote control has a service indicator for periodic maintenance reminder (min once a year). The service indicator measures voltage and is activated after 11 months (flashes every 4 seconds). After 12 months the indicator will glow steadily. The indicator is reset by holding down buttons on the remote control (top line, <fast up>, <fast down>) for 30 seconds.



## 16. Cleaning

Clean the Easy Hygiene Chair with detergent/disinfectants commonly used in healthcare (alcohol-based). The pillars should be cleaned with agents that dissolve grease and also remove lime stains. Raise the chair to maximum height when cleaning the pillars. Apply the cleaning agent and leave it to work according to the instructions (also allow it to run down inside the pillars); flush out. NOTE: Also clean the pillar base plate periodically. Do so by removing the bottom plug and applying cleaning agent directly in the pillar. Allow to work; flush out.

Read the warning text on the packaging/cleaning agents and in their data sheets.  
NOTE: To avoid crush injuries, make sure protective covers are always put back.

## 17. Troubleshooting when the Chair is Inoperable

NOTE: Chair cannot be operated above 65 cm seat height if the chair is tilted forward, nor can the seat be tilted forward if seat height is greater than 65 cm.  
Before troubleshooting begins, always restart the battery. Hold in the battery's OFF button for approx. 5 seconds. Wait for one minute. Activate the battery using the ON button).

- |  |   |
|--|---|
| <p>1 Check the battery charge via the remote control's battery indicator (if necessary, activate the remote control by pressing any button).</p> <p>1a Indicator shows green ==&gt;<br/>Calibrate the chair.</p> <p>1b Indicator shows red == &gt;<br/>Charge the battery</p> <p>1c Indicator lamp out ==&gt;<br/>Connect the remote control to the charger. If charging is indicated in the remote control, charge the battery as per instructions. If charging is not indicated, proceed to 2.</p> | <p>2 Switch off the battery manually using the battery Off button. Wait one minute. Activate the battery by pressing its On button. Check that the battery indicator lamp is lit or flashing</p> <p>Indicator lamp lit/flashing == &gt;<br/>Replace remote control and charge the battery as per the instructions.</p> <p>Indicator lamp not lit, not flashing ==&gt; Replace the battery</p> |
|--|---|

If the chair remains in operable following completion of the above, contact customer service.

## 18. Replacement of Remote Control

Incorrect remote control is easily changed by releasing the contact/ remote control on the left pillar - new remote control is mounted in the same way.

NOTE: It is important that contact is locked with the clamp lock to ensure IP X5

## 19. Recycling/Disposal

When the product is no longer usable it should be recycled in accordance with legislation and regulations in the country concerned. All electrical parts including batteries must be removed and recycled as electrical components. (Ask your local recycling station for further information about how the different materials in the product (metals, plastics, electronics) should be recycled).

## 20. Warranty

We normally provide a 2-year warranty on manufacturing defects (does not apply to wear details or battery).

The battery is given a 6 month warranty on manufacturing defects.  
For more information or questions please contact:

Direct Healthcare Group Sverige AB  
Torshamnsgatan 35,  
SE-164 40 Kista, Sweden

Tel: +46 (0)8-557 62 200  
info.se@directhealthcaregroup.com  
www.directhealthcaregroup.com

## 21. Maintenance

The chair is made from stainless steel/powder coated tubing and aluminium. Exposed, unpainted parts are made of aluminium or stainless steel. Make sure the product feels firm and stable – no fasteners may be loose. Damaged or defective parts should be replaced as soon as possible.

### Cleaning, general

- Clean the chair by wiping with regular cleaning agent (NOT Pentanol based) or use a washer/autoclave (max 85 C).
- Remove the seat and clean it separately or use a washer/autoclave (max 85 C).

NOTE: The remote control/control box (or the connector/female connector if the remote control is removed before washing) must be protected from high pressure water. Use a plastic bag or similar that can withstand washer water pressure. Place the remote control/control box or the connector/female connector so that running water cannot force its way in.

- Clean the pillars with detergent/disinfectants commonly used in healthcare (alcohol-based).
- Make sure the protective cover is installed at the bottom of each pillar.

### Special checks (at least once per year)

1. Armrest – check that slip protection/wrist protection are intact and secured.
2. Pillars (electric actuator/raise-lower) + electric actuator/tilt: check the function of the remote control and that the electric actuator attachment devices are not loose.
3. Seat/stopped seat – whole and without cracks. No sharp edges may be present.
4. Footrest platforms – whole and adjustable in the intended manner. Check that the clips are whole and properly fastened. Heel restraints must be in position at the back of each footrest platform.
5. Wheels – may not be stiff or loose. Also check that the brakes work.
6. Back strap; the back strap must be intact and may not have any holes or other damage to the belts and anchors.



## 22. Technical Specifications

### Material

Aluminium  
 Plastic (PP, PP/GS, PA, PA/GS, TPE, Silicone)  
 Textile Dartex  
 Foam (PUR)  
 Steel (Stainless)  
 Frame / stand Powder coating (polyester)

### Specification power system

## EASY SOFTBACK

Actuator	Raise/lower/pillars	Tilt function
Voltage	24V	24V
Lift	100kg/pelare	150 kg
Stroke	400 mm	75 mm
Installation dimensions	377 mm	198 mm
Protection class	N/A	IP66W
Protection class pillars	IPX5	
Speed - without load	32 mm/s	11,5 mm/s
Speed - full load	19 mm/s	7 mm/s
Blocking when lifting	100 kg	150 kg
Operating temperature	5-45°C	5-45°C

### Battery TBB6

Voltage	24 V
Capacity	5 Ah
Type	Pb
Protection class	IP66W

### Battery charger TP9

Voltage in	100-240V 50/60 Hz
Voltage	29V

### Control box TC14

Processor	MCU 3 motors
Protection class	IP66W

### Wiring Diagrams / Control box

1. The control box is reached by removing the protective cap - 4 screws.
2. Control box with battery with removed cover.
3. Actuators (2x up / down and 1x tilt), The actuators are connected directly to the control box as below. Remote control and battery are connected via spindle cable to control box as below.



## EASY SOFTBACK

Control box (A):

Spindle cable (B):

1	Connection connector # 1 / Spindle cable	1	Connects to input # 1 on control box
2	Actuators up / down - left	5	Remote control
3	Actuators up / down - right	6	Battery
4	Actuators tilt	7	Connects to outgoing connector on control box
7	Connected to spindle cable # 7		

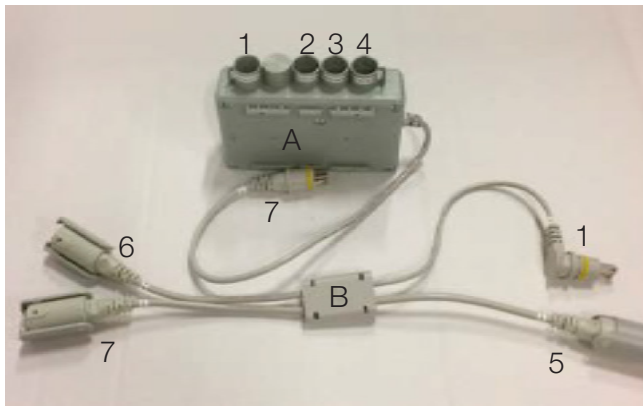

### 23. Dimensions

All dimensions in millimeters and with 125 mm wheels. When using Double wheels / 100mm, width over wheels increases by + 30mm.

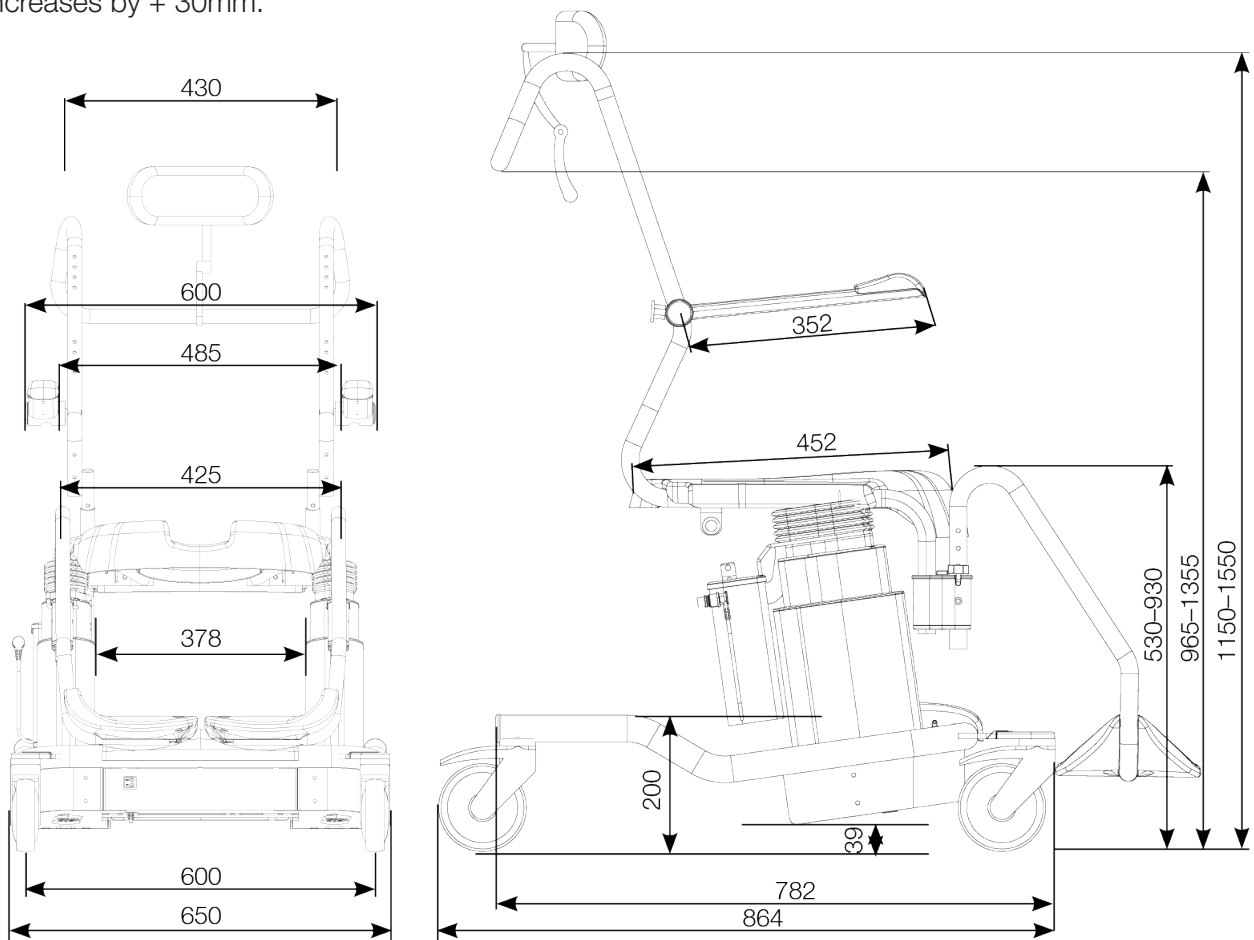

## 24. Information on EMC

The Easy Hygiene Chair has been tested to work in Hospitals and Home Health Care environments. The main function of the Hygiene Chair is to be able to operate upwards / downwards, backwards / forwards as well as charging the battery. Testing has shown that as long as the chair is subject to interference within the limits of this standard, no loss of main functions can be detected. Disturbances that are more powerful than these tests show, can affect the functions of the Hygiene Chair in such a way that they are manoeuvrable.

The Hygiene Chair consists of the following cables:

- AC cable for charger, 3 conductors, 2.0 m
- DC cable between charger and remote control, 2 split, 1.0m
- Signal - cable between control box and remote control, 2.5m

**WARNING:** Always replace the Hygiene Chair's electrical components or cabling with original parts from supplier. Failure to do so may affect the product's EMC approval.

Avoid placing / using the chair less than 0.35m from other medical equipment and / or mobile phones (or other transmitting equipment). This is because there is then a risk that the main functions of the product will not work as intended or that our product may interfere with other medical equipment.

## 25. Further Information on EMC, Advanced

The Easy Hygiene Chair ("product") is intended for use in the electromagnetic environment specified below. The customer or the user of the product should assure that it is used in such an environment.		
Emissions test	Compliance	Electromagnetic environment - guidance
RF emissions CISPR 11	Group 1	The product uses RF energy only for its internal function. Therefore, its RF emissions are very low and are not likely to cause any interference in nearby electronic equipment.
RF emissions CISPR 11	Class B	The product is suitable for use in all establishments including domestic establishments and those directly connected to the public low-voltage power supply network that supplies buildings used for domestic purposes.
Harmonic emissions IEC 61000-3-2	Class A	
Voltage fluctuations/ flicker emissions IEC 61000-3-3	Complies	



EASY SOFTBACK

The product is intended for use in the electromagnetic environment specified below. The customer or the user of the product should assure that it is used in such an environment.			
Immunity test	IEC 60601 test level	Compliance level	Electromagnetic environment - guidance
Electrostatic discharge (ESD) IEC 61000-4-2	+/- 8 kV contact +/- 2,4,8,15 kV air	+/- 8 kV contact +/- 2,4,8,15 kV air	Floors should be wood, concrete or ceramic tile. If floors are covered with synthetic material, the relative humidity should be at least 30 %.
Electrical fast transient / Burst IEC 61000-4-4	+/- 2 kV for power supply lines  +/- 1 kV for input/output lines	+/- 2 kV for power supply lines  n/a. for input/output lines	Mains power quality should be that of a typical commercial or hospital environment.
Surge IEC 61000-4-5	+/- 1 kV differential mode  +/- 2 kV common mode	+/- 1 kV differential mode  n/a. for common mode	Mains power quality should be that of a typical commercial or hospital environment.
Voltage dips, short interruptions and voltage variations on power supply input lines IEC 61000-4-11	<5 % UT (>95 % dip in UT) for 0,5 cycle  40 % UT (60 % dip in UT) for 5 cycles  70 % UT (30 % dip in UT) for 25 cycles  <5 % UT (>95 % dip in UT) for 5 sec	<5 % UT (>95 % dip in UT) for 0,5 cycle  40 % UT (60 % dip in UT) for 5 cycles  70 % UT (30 % dip in UT) for 25 cycles  <5 % UT (>95 % dip in UT) for 5 sec	Mains power quality should be that of a typical commercial or hospital environment. If the user of the [Equipment or System] requires continued operation during power mains interruptions, it is recommended that the [Equipment or System] be powered from an uninterruptible power supply or battery.
Power frequency (50/60 Hz) magnetic field IEC 61000-4-8	30 A/m	30 A/m	Power frequency magnetic fields should be at levels characteristic of a typical location in a typical commercial or hospital environment.
NOTE UT is the a.c. mains voltage prior to application of the test level.			

EASY SOFTBACK

The product is intended for use in the electromagnetic environment specified below.  
The customer or the user of the product should assure that it is used in such an environment.

Immunity test	IEC 60601 test level	Compliance level	Electromagnetic environment - guidance
			<p>Portable and mobile RF communications equipment should be used no closer than 0,35m to any part of the product, including cables, than the recommended separation distance calculated from the equation applicable to the frequency of the transmitter. Recommended separation distance</p> <p><math>d = 1,2\sqrt{P}</math>      80 MHz to 800 MHz</p> <p><math>d = 2,3\sqrt{P}</math>      800 MHz to 2.5 GHz</p> <p>where P is the maximum output power rating of the transmitter in watts (W) according to the transmitter manufacturer and d is the recommended separation distance in meters (m).</p> <p>Field strengths from fixed RF transmitters, as determined by an electromagnetic site survey, a should be less than the compliance level in each frequency range.</p> <p>b</p> <p>Interference may occur in the vicinity of equipment marked with the following symbol.</p> 

NOTE 1 At 80MHz and 800MHz, the higher frequency range applies.  
NOTE 2 These guidelines may not apply in all situations. Electromagnetic propagation is affected by absorption and reflected from structures, objects and people.

Field strengths from fixed transmitters, such as base stations for radio (cellular/cordless) telephones and land mobile radios, amateur radio, AM and FM radio broadcast and TV broadcast cannot be predicted theoretically with accuracy. To assess the electromagnetic environment due to fixed RF transmitters, an electromagnetic site survey should be considered. If the measured field strength in the location in which the product is used exceeds the applicable RF compliance level above, the product should be observed to verify normal operation. If abnormal performance is observed, additional measures may be necessary, such as reorienting or relocating the product.

b Over the frequency range 150 kHz to 80 MHz, field strengths should be less than 10 V/m.

## 26. Parts List

1	57-283-EASY	Headrest for SB incl. attachment
2	58-220-1	Backrest SB
3	57-288-2	Armrest lock
4	58-245-L/R	Armrest SB (left/right), alloy detail only
5	58-209	Handrest
6	58-285-1	Seat frame SB
7	57-250-1	Plastic seat
7	56-233	Plastic seat/keyhole, green
8	58-280-L/R	Pillars complete (Left / Right)
9	58-277	Holder (footrests)
10	58-283-1-L/R	Footrest (left/right)
11	58-296-1	Footrest
12	58-281-1	Bottom frame
13	57-049-RF	Wheel with bolt - fully braked
13	57-040-RF	Wheel with bolt - directional lock and fully braked
14	58-360	Cover
15	57-793	End plug
16	58-253	Battery Pb 5,0 Ah
17	58-291	Cover control box
18	58-293	Bellows (silicone)
19	58-282	Cap (tilt actuator)
20	58-252	Tilt actuator TA16
21	58-290	Cover plate on the left
21	58-289	Cover plate right incl. holder tilt actuator
22	57-235	Cover/armrest

## 27. Spare Parts

Part no.	Description
58-255	Charger, universal volt
58-255-1/2/3/4	Cable to 58-255 (EU; UK; US; AUS)
58-254	Remote control for Easy



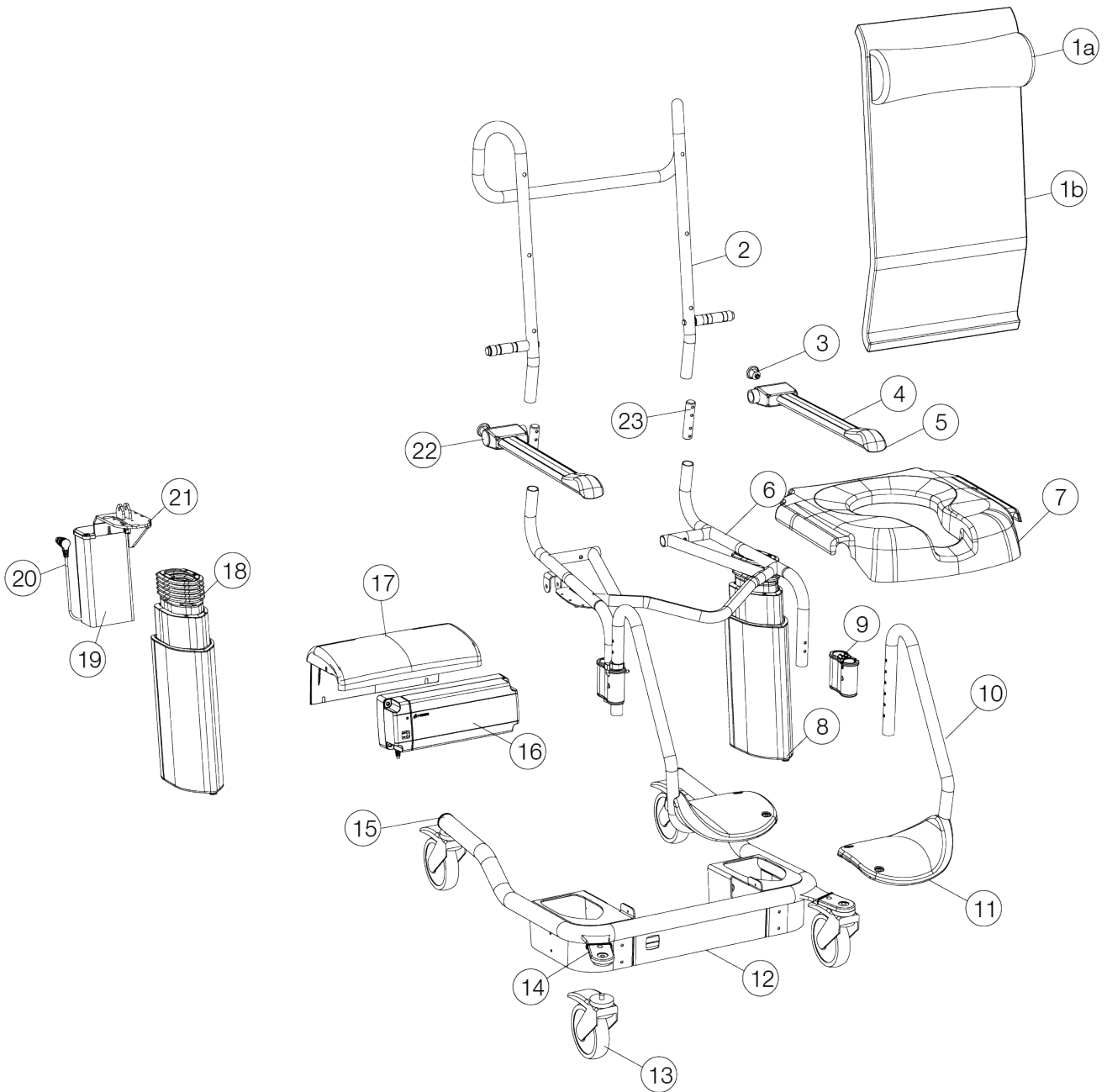









EASY SOFTBACK



## 28. Accessories

Part no.	Description
56-205	Shower seat around hole
56-206	Soft PU seat
56-209	Sanitary Pan
56-212-EASY	Barrier (52cm), Easy
56-213	Splashback
56-214	Armrest lock (M8)
56-216	Infill
56-217	Waist belt / Thigh belt, Hygiene Chairs
56-218	Slides
56-220-EASY	Heel strap kit (pair), Easy
56-221	Width kit (+ 50mm) Easy SB
56-227-L	Calf rest, left
56-227-R	Calf rest, right
56-229	Chest belt
56-232	Plug, soft seat
56-234	Comfort seat (back opening), green, Easy
56-259-L	Calf rest left, Easy
56-259-R	Calf rest right, Easy
56-260-L	Footrest left, Easy
56-260-R	Footrest right, Easy

## 29. Table of Symbols

	This product complies with the requirements of the Medical Device Regulation 2017/745		Visual Inspection
	Medical Device		Read the manual
	Caution		Product Code
	Manufacturer information		Batch Code
	Type BF, according to the degree of protection against electric shock		The device is intended for indoor use
	WEEE Symbol May not be discarded in domestic waste		Class II Equipment
	Duty Cycle: 2 min in active (ON) mode. 18 min in rest (OFF) mode.		



Medical Device Class I

Medical Device Class I. The product complies with the requirements of the Medical Devices Regulation 2017/745.

# Direct Healthcare Group

Advancing Movement & Health®

Direct Healthcare Group Sverige AB  
Torshamnsgatan 35,  
SE-164 40 Kista, Sweden

Tel: +46 (0)8-557 62 200  
info@directhealthcaregroup.com  
www.directhealthcaregroup.com