

Prijslijst

Badkamerhulpmiddelen

2021



Meer dan 80 jaar ervaring in het comfort van veiligheid

Linido's producten voor aangepaste badkamers zijn ontworpen om ergonomische steun, comfort en grotere zelfstandigheid te bieden aan gebruikers in verschillende bad-, douche- en toiletsituaties en tegelijkertijd gemak en veiligheid te bieden aan de verzorgende. Of u nu zelfstandig leeft, woont of werkt in een instelling en een kleinere of grotere beperking heeft, voor iedereen is er een passende oplossing. De badkamerproducten van Linido bieden een groot assortiment van veilige, bruikbare, duurzame en ergonomische hulpmiddelen en accessoires, die zorgen voor toegankelijke, veilige en ook nog eens mooie badkamers. De badkamerproducten van Linido zijn geschikt voor alle omgevingen, van kleinere privé badkamers thuis naar openbare omgevingen, hotels en grote ziekenhuizen. Met badkamerhulpmiddelen van Linido kan iedereen het comfort van veiligheid beleven, elke dag.

Ontworpen en geproduceerd voor duurzaam gebruik

Linido is met 80 jaar ervaring dé specialist op het gebied van badkameraanpassingen. Hulpmiddelen produceren waarop u kunt vertrouwen, die doen wat ze beloven én lang meegaan – dat is ons beroep en onze passie.

Direct Healthcare Group biedt oplossingen en ondersteuning om de zelfstandigheid van ouderen en mensen met een beperking te verhogen, evenals het makkelijker maken voor diegenen die voor hen zorgen.

Inhoudsopgave

Kleuren	3
Wandbeugels	4
Toiletsteunen	7
Douchezittingen	8
Krukken en stoelen	9
Accessoires	10
Spiegels	11
Toiletsignalering	11

Kleuren en afwerkingen

Geef uw badkamer karakter met de hoogwaardige afwerkingen van Ponte Giulio. Met kleuren als goud, koper en mat zwart kunt u de producten naadloos laten aansluiten op uw badkamerinrichting. Naast de 6 standaardkleuren biedt Ponte Giulio ook nog een 7-tal speciale kleuren welke op aanvraag leverbaar zijn.

Breng contrast in de badkamer

Het subtiel aanbrengen van contrast verfraait niet alleen uw badkamer, het maakt hem ook veiliger. Door het gebruik van contrasterende elementen in de badkamer wordt de oriëntatie vergemakkelijkt.

Standaardkleuren

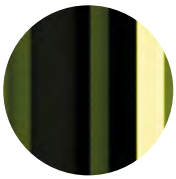

G9
Lime

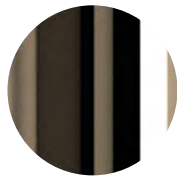

C1
Chrome

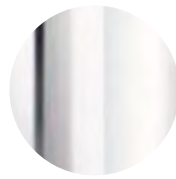

N2
Bright



P5
Aubergine

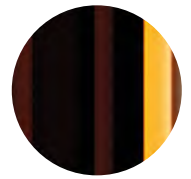

R2
Copper



WE
Hemp white

Standaardkleuren op aanvraag

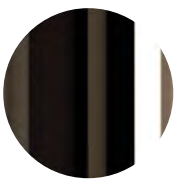

E1
Black nickel

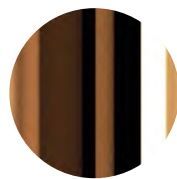

E2
Pink Gold



E3
Satin gold



E4
Satin pink gold

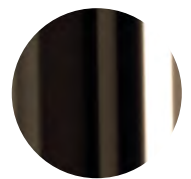

E5
Satin black nickel



E6
Dark satin bronze

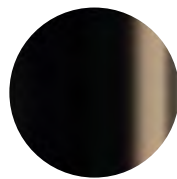

E7
Satin bronze nickel

Wandbeugels - 38 t/m 130 cm

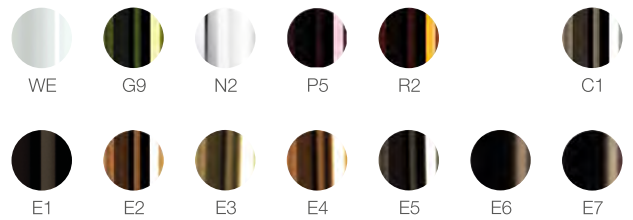
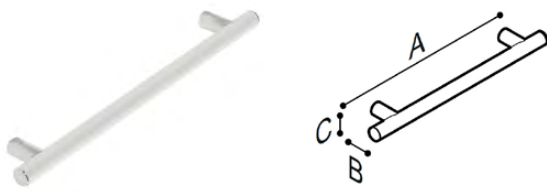

Artikel nr.	Kleuren	AxBxC (mm)	Gewicht (kg)	Max. belasting	Prijs excl.	Kleur	Prijs excl.
G18UAS32 XX	WE, G9, N2, P5, R2	386x82x32	0,78	150	84	C1	109
G18UAS33 XX	WE, G9, N2, P5, R2	486x82x32	0,88	150	86	C1	112
G18UAS34 XX	WE, G9, N2, P5, R2	586x82x32	0,98	150	88	C1	114
G18UAS35 XX	WE, G9, N2, P5, R2	686x82x32	1,08	150	89	C1	116
G18UAS37 XX	WE, G9, N2, P5, R2	906x82x32	1,30	150	91	C1	118
G18UAS38 XX	WE, G9, N2, P5, R2	1006x82x32	1,46	120	124	C1	161
G18UAS39 XX	WE, G9, N2, P5, R2	1306x82x32	1,95	120	136	C1	177

Artikel nr.	Kleuren	AxBxC (mm)	Gewicht (kg)	Max. belasting	Prijs excl.
G18UAS32 XX	E1 t/m E7	386x82x32	0,78	150	154
G18UAS33 XX	E1 t/m E7	486x82x32	0,88	150	170
G18UAS34 XX	E1 t/m E7	586x82x32	0,98	150	190
G18UAS35 XX	E1 t/m E7	686x82x32	1,08	150	207
G18UAS37 XX	E1 t/m E7	906x82x32	1,30	150	252
G18UAS38 XX	E1 t/m E7	1006x82x32	1,46	120	271
G18UAS39 XX	E1 t/m E7	1306x82x32	1,95	120	331

Wandbeugel - 175 cm

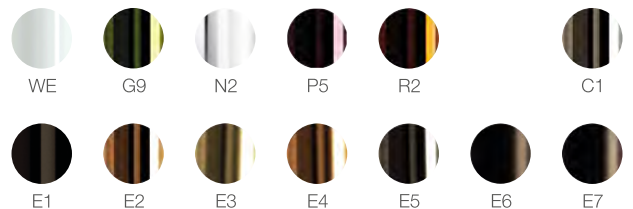
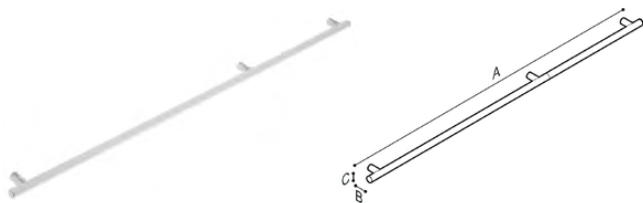

Artikel nr.	Kleuren	AxBxC (mm)	Gewicht (kg)	Max. belasting	Prijs excl.	Kleur	Prijs excl.
G18UAS40 XX	WE, G9, N2, P5, R2	1756x82x32	2,3	120	192	C1	249
G18UAS40 XX	E1 t/m E7	1756x82x32	2,3	120	510		

Planchet voor de horizontale wandbeugel



Artikel nr.	AxBxC (mm)	Gewicht (kg)	Prijs excl.
F47ANM10W3	270x95x42	0,64	80

Wandbeugel verticale montage - 175 cm

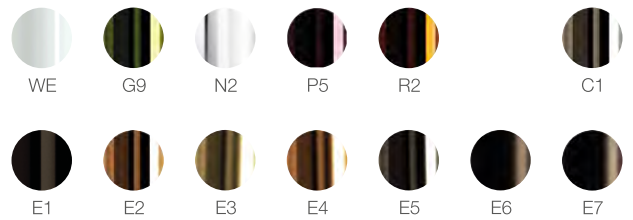

Artikel nr.	Kleuren	AxBxC (mm)	Gewicht (kg)	Max. belasting	Prijs excl.	Kleur	Prijs excl.
G18UAS41 XX	WE, G9, N2, P5, R2	1756x82x32	2,2	120	154	C1	200

Artikel nr.	Kleuren	AxBxC (mm)	Gewicht (kg)	Max. belasting	Prijs excl.
G18UAS41 XX	E1 t/m E7	1756x82x32	2,2	120	479

Container voor verticale wandbeugel

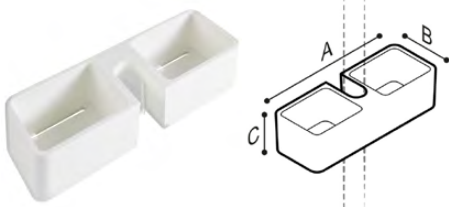

Artikel nr.	AxBxC (mm)	Gewicht (kg)	Max. belasting	Prijs excl.
F47ANS01xx	272x100x70	0,42	5 kg	109

Wandbeugel 90 graden - 40,3 cm

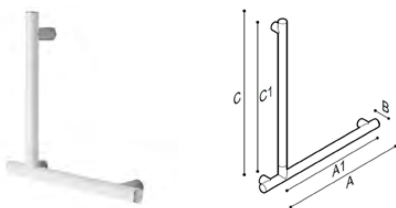

Artikel nr.	AxBxC (mm)	Gewicht (kg)	Max. belasting	Prijs excl.
G18UBL34 XX	406x82x403 (links)	1,2	150	168
G18UBR34 XX	406x82x403 (rechts)	1,2	150	168

Wandbeugel 90 graden - 60,3 cm

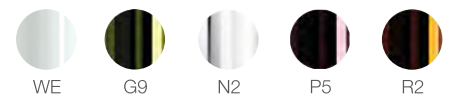

Artikel nr.	AxBxC (mm)	Gewicht (kg)	Max. belasting	Prijs excl.
G18UBL35 XX	406x82x403 (links)	1,5	150	168
G18UBR35 XX	406x82x403 (rechts)	1,5	150	168

Hoekwandbeugel 80,3 cm

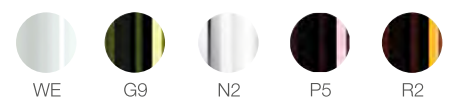
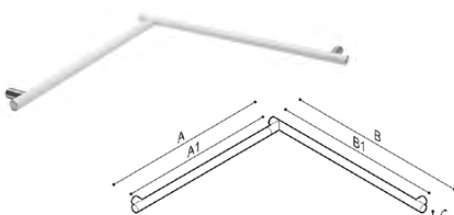

Artikel nr.	AxBxC (mm)	Gewicht (kg)	Max. belasting	Prijs excl.
G18UBS31 XX	803x803x32	2,1	120	169

Glijstangset



Artikel nr.	AxBxC (mm)	Gewicht (kg)	Max. belasting	Prijs excl.
G18UOS31 XX	32x82x1256	1,67	150	168

Wandbeugel 90 graden - 40,3 cm

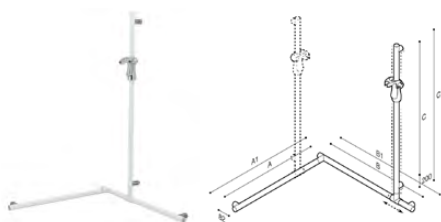

Artikel nr.	AxBxC (mm)	Gewicht (kg)	Max. belasting	Prijs excl.
G18UES30 XX	803x803x1200	3,77	150	318

Toiletsteunen

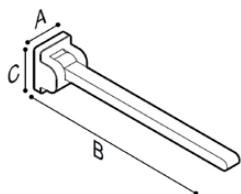

WE



DD



PB

xx verwijst naar de kleuren van de arm
XX verwijst naar de kleuren van de afdekkap



C1

xx verwijst naar de kleuren van de arm
XX verwijst naar de kleuren van de afdekkap

Artikel nr.	Kleuren	AxBxC (mm)	Gewicht (kg)	Max. belasting	Prijs excl.	Kleur	Prijs excl.
G18JCS07 xx XX	WE, DD, PB	100x600x120	2,7	150	289	C1	311
G18JCS08 xx XX	WE, DD, PB	100x700x120	3	150	311	C1	332
G18JCS08 xx XX	WE, DD, PB	100x850x120	3,4	150	364	C1	386

Afdekkap



WE



DD



C1

Artikel nr.	Kleuren	Prijs excl.	Kleur	Prijs excl.
F18JIS01 XX	WE, DD	11	C1	16

Toiletrolhouder voor toiletsteun



N2

Artikel nr.	Prijs excl.
F18AGS01N2	32

Armlegger voor toiletsteun



WE



DD

Artikel nr.	Prijs excl.
F18JMS01 XX	16

Douchezitting

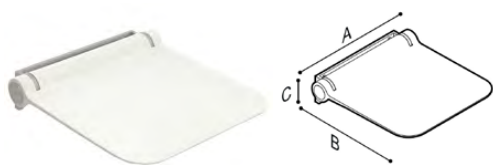

Artikel nr.	AxBxC (mm)	Gewicht (kg)	Max. belasting	Prijs excl.
G12JDS05 XX	425x460x110	6	150	407

Douchezitting afneembaar

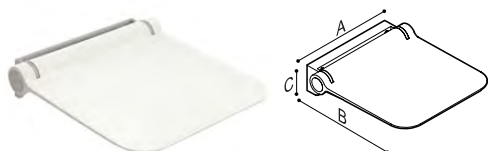

Artikel nr.	AxBxC (mm)	Gewicht (kg)	Max. belasting	Prijs excl.
G12JDS08 XX	425x460x110	6	150	€456

Rugleuning voor douchezitting



Artikel nr.	AxBxC (mm)	Gewicht (kg)	Max. belasting	Prijs excl.
G12JDS06xx	420x40x270	1,6	nvt	149

Rugleuning met armleggers voor douchezitting



Artikel nr.	AxBxC (mm)	Gewicht (kg)	Max. belasting	Prijs excl.
G12JDS07xx	600x259x270	4,2	50 kg	371

Afdekplaat tbv douchezitting afneembaar



Artikel nr.	AxBxC (mm)	Gewicht (kg)	Max. belasting	Prijs excl.
F18JIS02 XX	326x20x106,5	0,6	nvt	55

Kruk

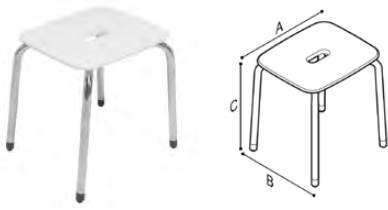

Artikel nr.	Kleuren	AxBxC (mm)	Gewicht (kg)	Max. belasting	Prijs excl.
G12JDS02 xx XX	Kleuren zitting: WE, DD, PB Kleuren frame: WE, G9, P5, R2	410x370x445	5	150	289
G12JDS02 xx N2	Kleuren zitting: WE, DD, PB Kleur frame: N2	410x370x445	5	150	273

Stoel met rugleuning en armleggers



Artikel nr.	Kleuren	AxBxC (mm)	Gewicht (kg)	Max. belasting	Prijs excl.
G12JDS04 xx XX	Kleuren zitting: WE, DD, PB Kleuren frame: WE, G9, P5, R2	420x530x735	7,2	150	521
G12JDS04 xx N2	Kleuren zitting: WE, DD, PB Kleur frame: N2	420x530x735	7,2	150	499

Kleding-/handdoekhaak

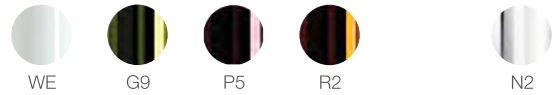
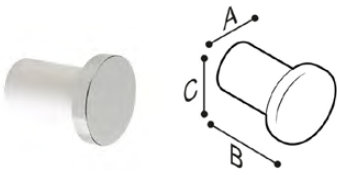

Artikel nr.	Kleuren	AxBxC (mm)	Gewicht (kg)	Max. belasting	Prijs excl.
F18AKS02 XX	WE, G9, P5, R2	40x50x40	0,15	150	30
F18AKS02 N2	N2	40x50x40	0,15	150	27

Reserverolhouder

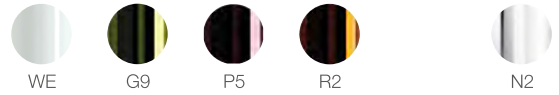

Artikel nr.	Kleuren	AxBxC (mm)	Gewicht (kg)	Max. belasting	Prijs excl.
F18AGS03 XX	WE, G9, P5, R2	40x110x40	0,2	150	39
F18AGS03N2	N2	40x110x40	0,2	150	34

Hoek douchekorf

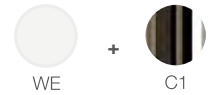

Artikel nr.	AxBxC (mm)	Gewicht (kg)	Prijs excl.
F47ANS11W1	190x190x75	1,4	109

Zeepdispenser

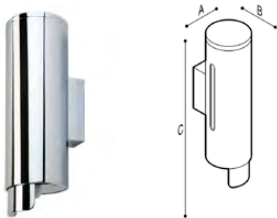

Artikel nr.	AxBxC (mm)	Inhoud liter	Prijs excl.
F47ACS01	70x87x238	1,2 l	145
F47ACS02	55x72x212	0,85 l	135

Make-up spiegel

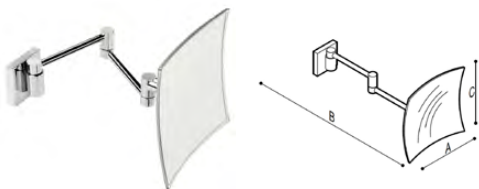

Artikel nr.	AxBxC (mm)	Gewicht (kg)	Prijs excl.
F47ATS14	211x423x211	1,5	170

Kantelbare spiegel

5 mm dik, met geïntegreerd LED-verlichtingssysteem en sensorschakelaar

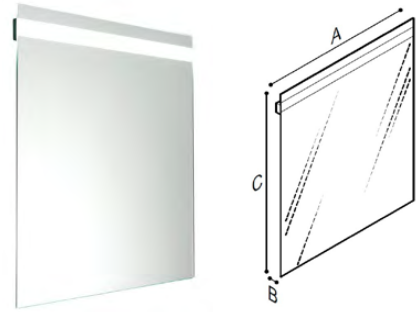

Artikel nr.	AxBxC (mm)	Gewicht (kg)	Prijs excl.
F47JPS03	680x80x750 mm	7	455

Spiegel

5 mm dik, met geïntegreerd LED-verlichtingssysteem en sensorschakelaar

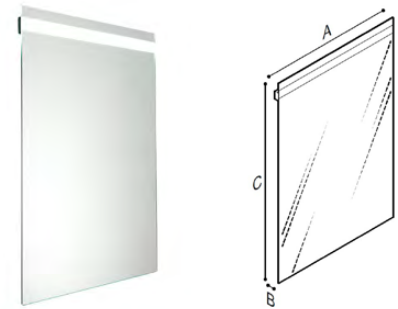

Artikel nr.	AxBxC (mm)	Gewicht (kg)	Prijs excl.
F47ATS18	660x27x950	8,5	435

Spiegel

5 mm dik, met geïntegreerd LED-verlichtingssysteem en sensorschakelaar

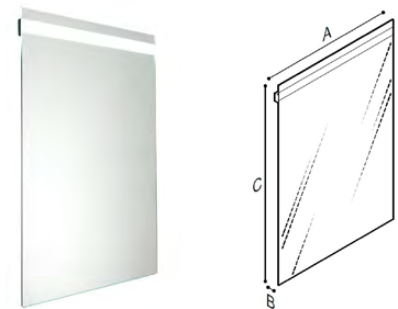

Artikel nr.	AxBxC (mm)	Gewicht (kg)	Prijs excl.
F47ATS19	1000x30x950	13	568

Toiletsignalering



MAN



VROUW



MINDERVERVALIDE



COMMODE



UNISEX

Artikel nr.	AxBxC (mm)	Signalering	Prijs excl.
N41KSS01	130x130	man	15
N41KSS02	130x130	vrouw	15
N41KSS03	130x130	mindervalide	15
N41KSS04	130x130	commode	15
N41KSS05	130x130	unisex	15

Direct Healthcare Group

Advancing Movement & Health*

Direct Healthcare Group BV

Weteringweg 5-9
2641 KM Pijnacker
Tel: +31 (0)15 369 54 40
www.directhealthcaregroup.com/nl
info.nl@directhealthcaregroup.com