



Meer dan 80 jaar ervaring in het comfort van veiligheid

Linido's producten voor aangepaste badkamers zijn ontworpen om ergonomische steun, comfort en grotere zelfstandigheid te bieden aan gebruikers in verschillende bad-, douche- en toiletsituaties en tegelijkertijd gemak en veiligheid te bieden aan de verzorgende. Of u nu zelfstandig leeft, woont of werkt in een instelling en een kleinere of grotere beperking heeft, voor iedereen is er een passende oplossing. De badkamerproducten van Linido bieden een groot assortiment van veilige, bruikbare, duurzame en ergonomische hulpmiddelen en accessoires, die zorgen voor toegankelijke, veilige en ook nog eens mooie badkamers. De badkamerproducten van Linido zijn geschikt voor alle omgevingen, van kleinere privé badkamers thuis naar openbare omgevingen, hotels en grote ziekenhuizen. Met badkamerhulpmiddelen van Linido kan iedereen het comfort van veiligheid beleven, elke dag.

Ontworpen en geproduceerd voor duurzaam gebruik

Linido is met 80 jaar ervaring dé specialist op het gebied van badkeraanpassingen. Hulpmiddelen produceren waarop u kunt vertrouwen, die doen wat ze beloven én lang meegaan – dat is ons beroep en onze passie.

Direct Healthcare Group biedt oplossingen en ondersteuning om de zelfstandigheid van ouderen en mensen met een beperking te verhogen, evenals het makkelijker maken voor diegenen die voor hen zorgen.

Inhoudsopgave

Kleuren	3
Wandbeugels	4
Toiletsteunen	7
Douchezittingen	8
Krukken en stoelen	9
Accessoires	10
Spiegels	11
Toiletsignalering	11

Kleuren en afwerkingen

Geef uw badkamer karakter met de hoogwaardige afwerkingen van Ponte Giulio. Met kleuren als goud, koper en mat zwart kunt u de producten naadloos laten aansluiten op uw badkamerinrichting. Naast de 7 standaardkleuren biedt Ponte Giulio ook nog een 4-tal speciale kleuren welke op aanvraag leverbaar zijn.

Breng contrast in de badkamer

Het subtiel aanbrengen van contrast verfraait niet alleen uw badkamer, het maakt hem ook veiliger. Door het gebruik van contrasterende elementen in de badkamer wordt de oriëntatie vergemakkelijkt.

Wandbeugels

Standaardkleuren



Kleuren op aanvraag

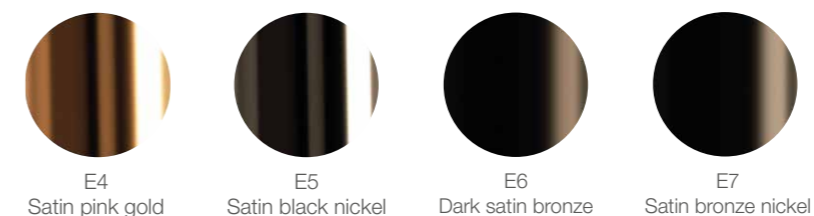

Toiletsteunen



Douchezittingen

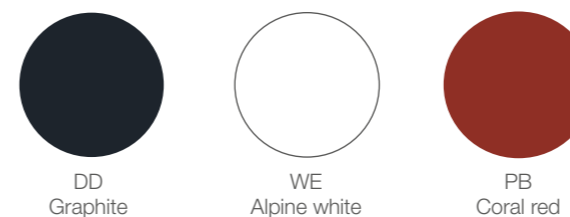

Wandbeugels - 38 t/m 130 cm

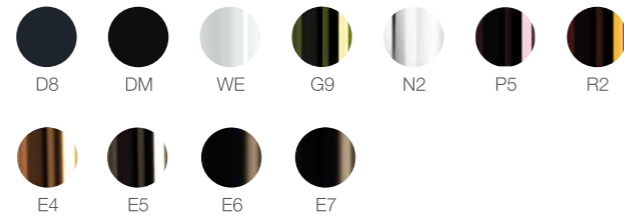
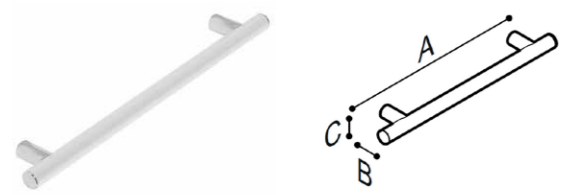

Artikel nr.	Kleuren	AxBxC (mm)	Gewicht (kg)	Max. belasting	Prijs excl.
G18UAS32 XX	D8, DM, WE, G9, N2, P5, R2	386x82x32	0,78	150	89
G18UAS33 XX	D8, DM, WE, G9, N2, P5, R2	486x82x32	0,88	150	91
G18UAS34 XX	D8, DM, WE, G9, N2, P5, R2	586x82x32	0,98	150	93
G18UAS35 XX	D8, DM, WE, G9, N2, P5, R2	686x82x32	1,08	150	94
G18UAS37 XX	D8, DM, WE, G9, N2, P5, R2	906x82x32	1,30	150	97
G18UAS38 XX	D8, DM, WE, G9, N2, P5, R2	1006x82x32	1,46	120	112
G18UAS39 XX	D8, DM, WE, G9, N2, P5, R2	1306x82x32	1,95	120	145

Artikel nr.	Kleuren	AxBxC (mm)	Gewicht (kg)	Max. belasting	Prijs excl.
G18UAS32 XX	E4 t/m E7	386x82x32	0,78	150	164
G18UAS33 XX	E4 t/m E7	486x82x32	0,88	150	181
G18UAS34 XX	E4 t/m E7	586x82x32	0,98	150	202
G18UAS35 XX	E4 t/m E7	686x82x32	1,08	150	220
G18UAS37 XX	E4 t/m E7	906x82x32	1,30	150	268
G18UAS38 XX	E4 t/m E7	1006x82x32	1,46	120	289
G18UAS39 XX	E4 t/m E7	1306x82x32	1,95	120	353

Wandbeugel - 175 cm

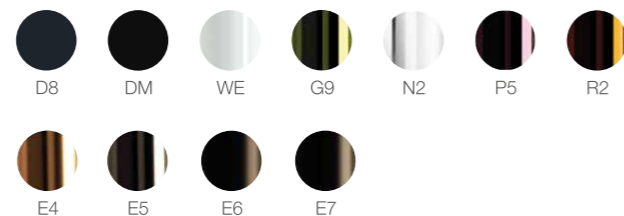
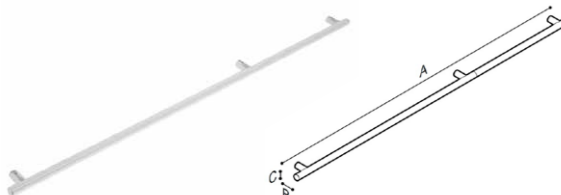

Artikel nr.	Kleuren	AxBxC (mm)	Gewicht (kg)	Max. belasting	Prijs excl.
G18UAS40 XX	D8, DM, WE, G9, N2, P5, R2	1756x82x32	2,3	120	204
G18UAS40 XX	E4 t/m E7	1756x82x32	2,3	120	544

Planchet voor de horizontale wandbeugel



Artikel nr.	AxBxC (mm)	Gewicht (kg)	Prijs excl.
F47ANM10 W3	270x95x42	0,64	85

Wandbeugel verticale montage - 175 cm



Artikel nr.	Kleuren	AxBxC (mm)	Gewicht (kg)	Max. belasting	Prijs excl.
G18UAS41 XX	D8, DM, WE, G9, N2, P5, R2	1756x82x32	2,2	120	164

Artikel nr.	Kleuren	AxBxC (mm)	Gewicht (kg)	Max. belasting	Prijs excl.
G18UAS41 XX	E4 t/m E7	1756x82x32	2,2	120	511

Container voor verticale wandbeugel

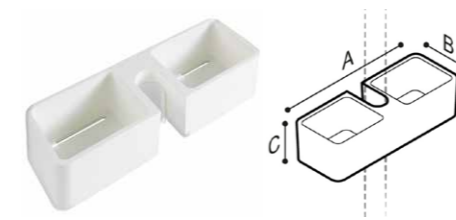

Artikel nr.	AxBxC (mm)	Gewicht (kg)	Max. belasting	Prijs excl.
F47ANS01 XX	272x100x70	0,42	5 kg	116

Wandbeugel 90 graden - 40,3 cm

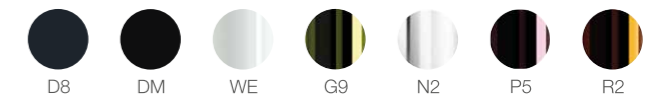
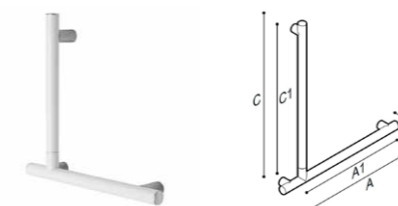

Artikel nr.	AxBxC (mm)	Gewicht (kg)	Max. belasting	Prijs excl.
G18UBL34 XX	406x82x403 (links)	1,2	150	179
G18UBR34 XX	406x82x403 (rechts)	1,2	150	179

Wandbeugel 90 graden - 60,3 cm

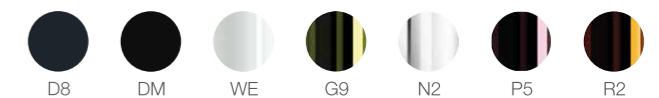
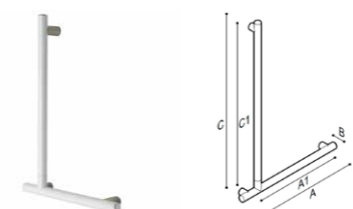

Artikel nr.	AxBxC (mm)	Gewicht (kg)	Max. belasting	Prijs excl.
G18UBL35 XX	406x82x603 (links)	1,5	150	202
G18UBR35 XX	406x82x603 (rechts)	1,5	150	202

Hoekwandbeugel 80,3 cm

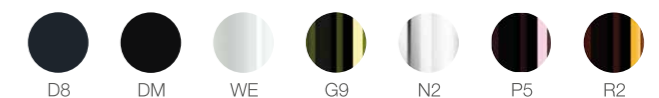
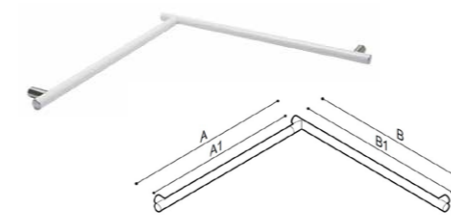

Artikel nr.	AxBxC (mm)	Gewicht (kg)	Max. belasting	Prijs excl.
G18UBS31 XX	803x803x32	2,1	120	180

Glijstangset

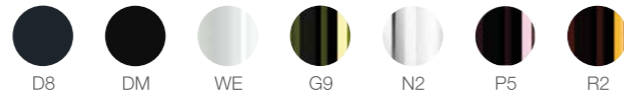
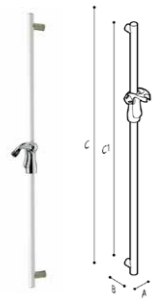

Artikel nr.	AxBxC (mm)	Gewicht (kg)	Max. belasting	Prijs excl.
G18UOS31 XX	32x82x1256	1,67	150	179

Wandbeugel 90 graden - 80,3 cm

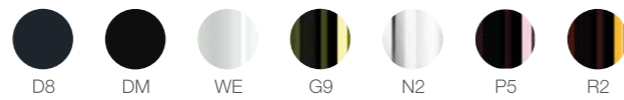
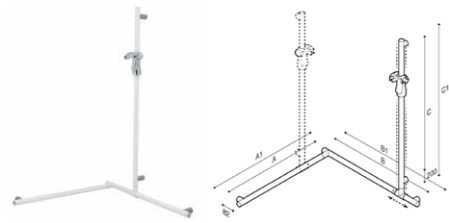

Artikel nr.	AxBxC (mm)	Gewicht (kg)	Max. belasting	Prijs excl.
G18UES30 XX	803x803x1200	3,77	150	339

Toiletsteunen

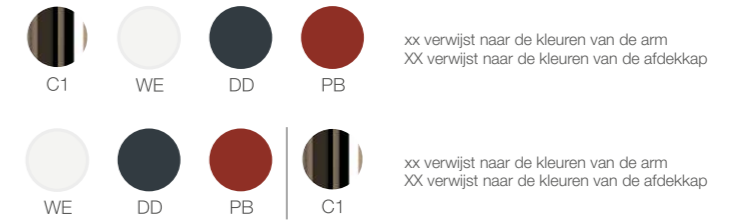
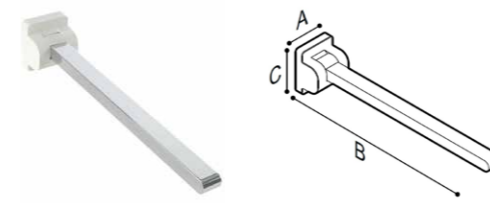

Artikel nr.	Kleuren	AxBxC (mm)	Gewicht (kg)	Max. belasting	Prijs excl.	Kleur	Prijs excl.
G18JCS07 xx XX	WE, DD, PB	100x600x120	2,7	150	308	C1	331
G18JCS08 xx XX	WE, DD, PB	100x700x120	3	150	331	C1	354
G18JCS09 xx XX	WE, DD, PB	100x850x120	3,4	150	388	C1	411

Afdekplaat

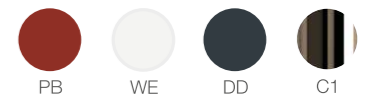

Artikel nr.	Kleuren	Prijs excl.
F18JIS01 XX	PB, WE, DD, C1	11

Toiletrolhouder voor toiletsteun



Artikel nr.	Prijs excl.
F18AGS01 N2	36

Armlegger voor toiletsteun

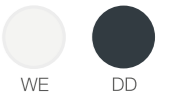

Artikel nr.	Prijs excl.
F18JMS01 XX	17

Douchezitting

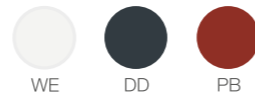
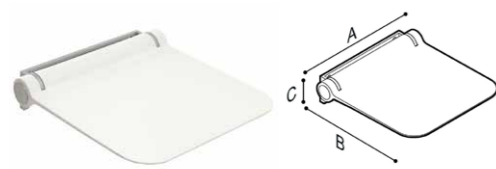

Artikel nr.	AxBxC (mm)	Gewicht (kg)	Max. belasting	Prijs excl.
G12JDS05 XX	425x460x110	6	150	434

Douchezitting afneembaar

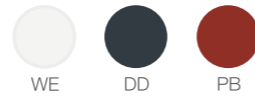

Artikel nr.	AxBxC (mm)	Gewicht (kg)	Max. belasting	Prijs excl.
G12JDS08 XX	425x460x110	6	150	486

Rugleuning voor douchezitting

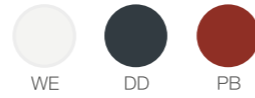

Artikel nr.	AxBxC (mm)	Gewicht (kg)	Max. belasting	Prijs excl.
G12JDS06 XX	420x40x270	1,6	nvt	158

Rugleuning met armleggers voor douchezitting

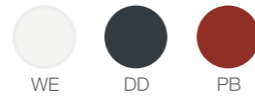

Artikel nr.	AxBxC (mm)	Gewicht (kg)	Max. belasting	Prijs excl.
G12JDS07 XX	600x259x270	4,2	50 kg	395

Afdekplaat tbv douchezitting afneembaar



Artikel nr.	AxBxC (mm)	Gewicht (kg)	Max. belasting	Prijs excl.
F18JIS02 XX	326x20x106,5	0,6	nvt	58

Kruk

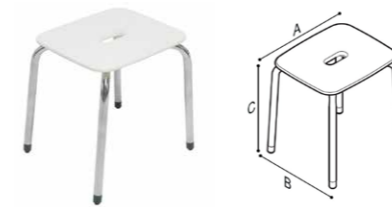

Artikel nr.	Kleuren	AxBxC (mm)	Gewicht (kg)	Max. belasting	Prijs excl.
G12JDS02 xx XX	Kleuren zitting: WE, DD, PB Kleuren frame: WE, G9, P5, R2	410x370x445	5	150	308
G12JDS02 xx N2	Kleuren zitting: WE, DD, PB Kleur frame: N2	410x370x445	5	150	291

Stoel met rugleuning en armleggers

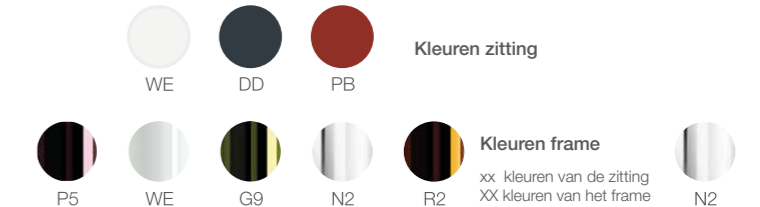

Artikel nr.	Kleuren	AxBxC (mm)	Gewicht (kg)	Max. belasting	Prijs excl.
G12JDS04 xx XX	Kleuren zitting: WE, DD, PB Kleuren frame: WE, G9, P5, R2	420x530x735	7,2	150	555
G12JDS04 xx N2	Kleuren zitting: WE, DD, PB Kleur frame: N2	420x530x735	7,2	150	532

Kleding-/handdoekhaak

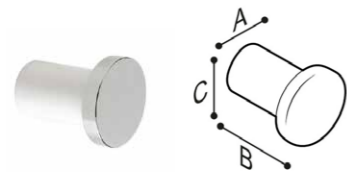

Eindkap altijd chroom

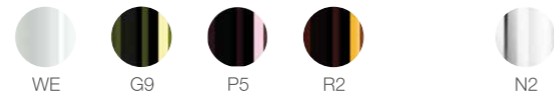

Artikel nr.	Kleuren	AxBxC (mm)	Gewicht (kg)	Max. belasting	Prijs excl.
F18AKS02 XX	WE, G9, P5, R2	40x50x40	0,15	150	32
F18AKS02 N2	N2	40x50x40	0,15	150	28

Reserverolhouder



Eindkap altijd chroom

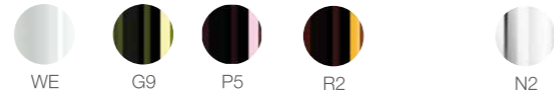

Artikel nr.	Kleuren	AxBxC (mm)	Gewicht (kg)	Max. belasting	Prijs excl.
F18AGS03 XX	WE, G9, P5, R2	40x110x40	0,2	150	34
F18AGS03 N2	N2	40x110x40	0,2	150	36

Hoek douchekorf

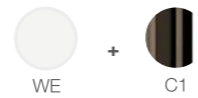

Artikel nr.	AxBxC (mm)	Gewicht (kg)	Prijs excl.
F47ANS11	190x190x75	1,4	109

Zeepdispenser

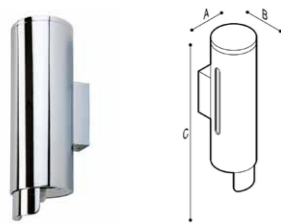

Artikel nr.	AxBxC (mm)	Inhoud liter	Prijs excl.
F47ACS01	70x87x238	1,2 l	145
F47ACS02	55x72x212	0,85 l	135

Make-up spiegel

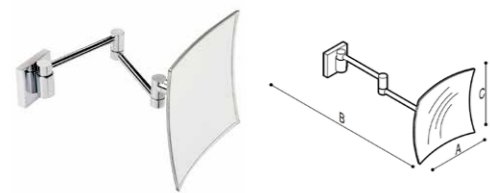

Artikel nr.	AxBxC (mm)	Gewicht (kg)	Prijs excl.
F47ATS14	211x423x211	1,5	170

Kantelbare spiegel

5 mm dik, met geïntegreerd LED-verlichtingssysteem en sensorschakelaar

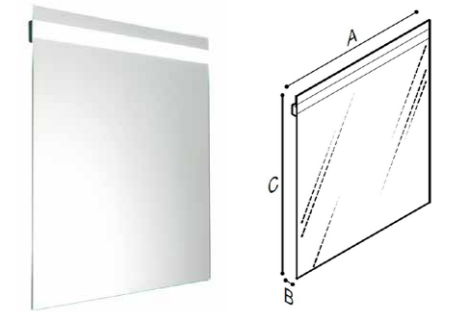

Artikel nr.	AxBxC (mm)	Gewicht (kg)	Prijs excl.
F47JPS03	680x80x750 mm	7	485

Spiegel

5 mm dik, met geïntegreerd LED-verlichtingssysteem en sensorschakelaar

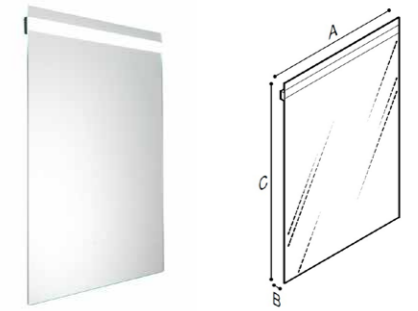

Artikel nr.	AxBxC (mm)	Gewicht (kg)	Prijs excl.
F47ATS18	660x27x950	8,5	464

Spiegel

5 mm dik, met geïntegreerd LED-verlichtingssysteem en sensorschakelaar

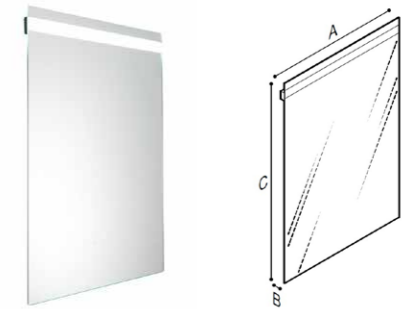

Artikel nr.	AxBxC (mm)	Gewicht (kg)	Prijs excl.
F47ATS19	1000x30x950	13	606

Toiletsignalering



Artikel nr.	AxBxC (mm)	Signalering	Prijs excl.
N41KSS01	130x130	man	15
N41KSS02	130x130	vrouw	15
N41KSS03	130x130	mindervalide	15
N41KSS04	130x130	commode	15
N41KSS05	130x130	unisex	15



Moving Health Forward

Direct Healthcare Group BV

Weteringweg 5-9
2641 KM Pijnacker
Tel: +31 (0)15 369 54 40
www.dhg-healthcare.com
info.nl@directhealthcaregroup.com