

ReTurn7600

SystemRoMedic™



User manual – English

Bruksanvisning – Svenska

Brukermanual – Norsk

Brugsvejledning – Dansk

Käyttöohje – Suomi

Gebrauchsanweisung – Deutsch

Handleiding – Nederlands

Manuel d'utilisation – Français

Manuale utente – Italiano

Manual de usuario – Español

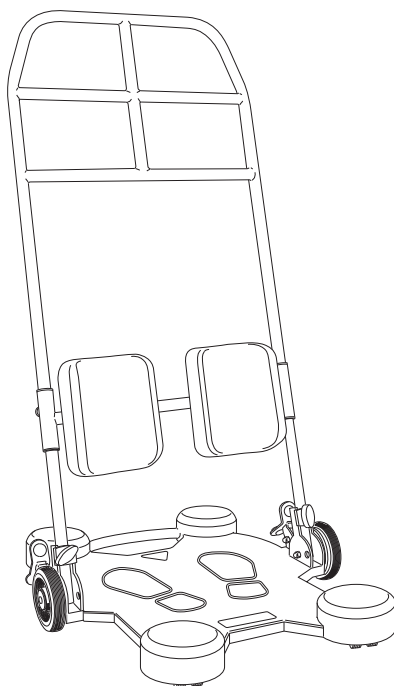

REF
7600

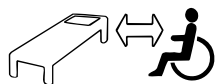

SWL: 205kg/450lbs

Table of contents

English	3-6
Svenska	7-10
Norsk	11-14
Dansk	15-18
Suomi	19-22
Deutsch	23-26
Netherlands	27-30
Français	31-34
Italiano	35-38
Español	39-42

Accessories	43
--------------------------	----

ReTurn7600 are used indoors for shorter transfers between wheelchair and bed, wheelchair and toilet/portable toilet/wheelchair or chair/armchair. ReTurn7600 can also be used to aid repositioning farther back in the chair. ReTurn7600 is designed for easy manoeuvring and use in confined spaces. It is easy to assemble and disassemble in just two sections for easier transport and storage.

Check Safety

Visual inspection

Check the condition and function of the assistive device regularly. Always inspect the product after laundering. Check to ensure that seams and material are free from damage. Check to ensure that fabric is not worn or faded. If there are signs of wear, the product must be discarded.

Always read the user manual

Always read the user manuals for all assistive devices used during a transfer. Keep the user manual where it is accessible to users of the product. Always make sure that you have the right version of the user manual. The most recent editions of user manuals are available for downloading from our website, www.handicare.com.

Assembly

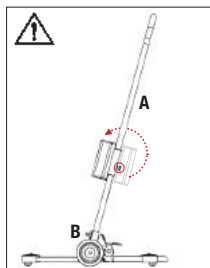

A. Push the rising ladder/tube down into the mounting fixtures on the chassis, so that the height-adjustment buttons are facing towards the caregiver.

B. Insert the fixture knobs and tighten. Check to ensure that the fixture knobs are securely tightened before using the ReTurn.

Transport

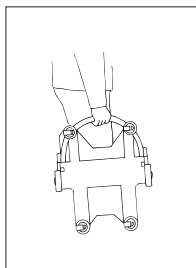

The chassis and raising ladder can be carried separately. Carry the chassis by holding the tube on the front end of the product.

Transport, e.g., by car, and storage are easy, since the ReTurn can be disassembled in two pieces.

Special requirements and conditions

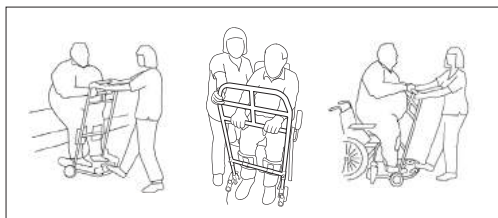

- ReTurn is intended for shorter transfers.
- Return can only be used on flat floor.
- The caregiver must always apply counter pressure in a safe way when the user is standing up, sitting down and during the actual transfer.

Note! Always perform a risk assessment before using ReTurn.

To transfer with ReTurn, the user must be able to:

- support weight while standing
- stand up and maintain balance (with support)
- grasp handles
- understand instructions

Chassis and placement of feet

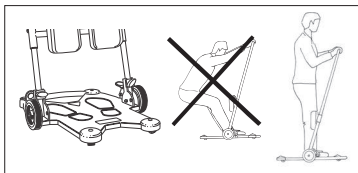

The feet are placed one on either side, see foot markings on base plate.

The user's weight must be centred on the product's support surface (all weight between the wheels); i.e., the user must be in a standing position. The user's weight must not be outside of the support surface.

Lower-leg support

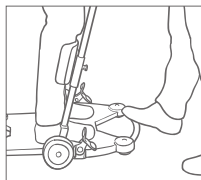

Adjust the lower-leg support so that the upper edge of the plate is about 3 cm/two fingers below the lower edge of the kneecaps. Pull the two pins to loosen. Adjust to the appropriate height.

Ensure that the pins lock securely into place. The lower-leg support can also be adjusted laterally.

Testing standing function



ReTurn is ideal for testing a user's standing function in cases where there is uncertainty as to whether the user is able to rise from a seated to a standing position.

Training standing function



ReTurn can be used to train the user's standing, sitting and sit-to-stand function. To measure improvement, use a stopwatch or clock with a second hand to time the user.

Transfers



Bed to wheelchair

Place the wheelchair at some distance from the bed to allow enough working space. Lock the wheelchair wheels. Place the user's feet on the base plate. The user grasps the raising ladder, leans forward, and then raises himself/herself.

Pull the ReTurn back somewhat, and then steer in towards the wheelchair.

Position the ReTurn close enough to enable good placement in the wheelchair. The caregiver applies counter pressure before the user sits down.

Brakes

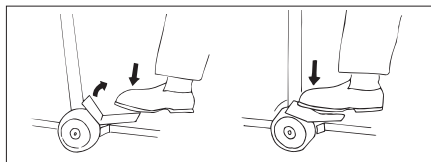

There is a brake for each wheel. With your foot, press down on the red marking on the brake plate. Press all the way down.

To release the brake, press on the brake plate so that it resumes its original position (green marking); ensure that the wheels roll freely.

Farther back in the chair

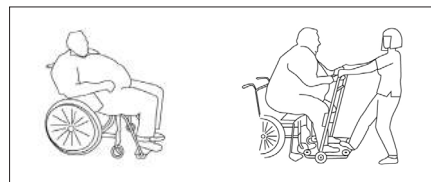

If the user slides forward in the wheelchair, the ReTurn can be used to help the user to slide farther back in the chair.

Remove/raise the wheelchair foot plates, and then run the ReTurn in towards the wheelchair. The user places his/her feet on the foot plate, grasps the raising ladder, leans forward, and then lifts from the seat. The caregiver provides counter pressure. Slide the user farther back in the chair when he/she has lifted slightly from the seat.

Using ReTurnBelt together with ReTurn7600

See manual for ReTurnBelt.

ReTurnBelt is used for raising from a seated to a standing position, and for support in the standing position in combination with the use of ReTurn transfer platform. ReTurnBelt has a more rigid lower section for easy application and an elastic upper section for a better and more comfortable fit. ReTurnBelt has several gripping alternatives and a locking strap for extra support and safety in connection with the use of the ReTurn platform.

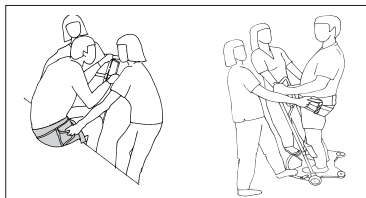

Two caregivers with ReTurnBelt

Brake the wheels on the ReTurn. The user then leans forward and grasps the handles on the ReTurn. The caregivers then grasp the handles on the ReTurnBelt.

ReTurnBelt allows different gripping alternatives, and helps and encourages the user to lean forward.

One caregiver helps the user to lean forward and provides support during raising.

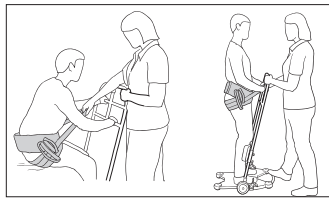

One caregiver with ReTurnBelt

Fasten the clasp without tensioning the strap. A click is heard when the clasp is secured.

Brake the wheels on ReTurn.

The caregiver encourages the user to lean forward while providing support during raising by grasping either a handle or the strap.

The user leans forward and grasps the handles on ReTurn.

When it is necessary to attach ReTurnBelt to ReTurn7600

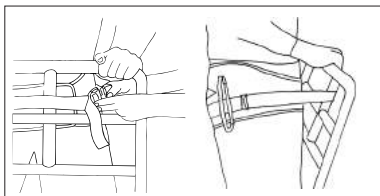

Do not secure the clasp on the ReTurnBelt before rising. When the user is in a standing position facing the ReTurn, the strap can be placed around one of the vertical handles.

Secure the clasp on the ReTurnBelt. A click is heard when the clasp is secured.

Now, transfer the user with ReTurn. Plan carefully to ensure that the transfer is as short as possible.

Sitting down

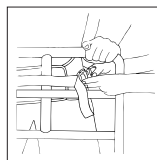

Brake the wheels on the ReTurn. Ensure that the user is standing in a secure position facing the ReTurn, so that the locking strap is loosened. Undo the clasp and remove the strap from the ReTurn. Fold it under the edge of the belt, so that it does not catch on anything. Help the user into a seated position with the help of the ReTurnBelt.



To toilet/shower chair

For transfers to the toilet, space is allowed for the caregiver to assist the user with the pants. The back also has a small recess that allows the user to get close to the toilet and achieve a good seated position.

Technical specifications

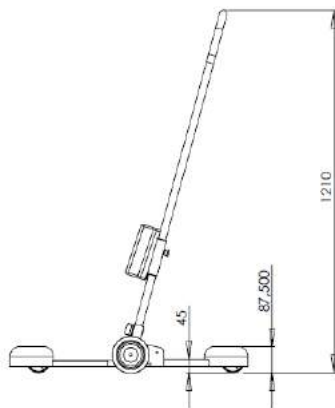
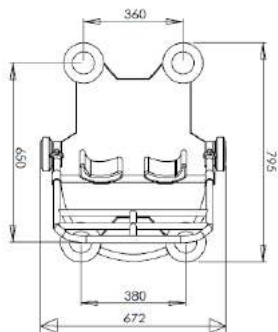

- Art.nr 7600 Complete ReTurn
- 7601 Ladder to 7600

SWL, Max weight: 205 kg/450 lbs (static load)

Total weight: 26 kg/57 lbs

Patented

Serialnumber

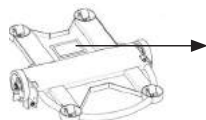

Care of the product

The surface of the product can be cleaned with warm water or a soap solution. If disinfection is needed, 70 % ethanol, 45 % isopropanol or similar should be used.

CE Medical Device Class I

Medical Device Class I. The product complies with the requirements of the Medical Devices Directive 93/42/EEC.

Contact your local distributor if you have any questions about the product and its use. See www.handicare.com for a complete list of distributors.

Expected lifetime

Up to 10 years of normal use

Accessories

ReTurnBelt

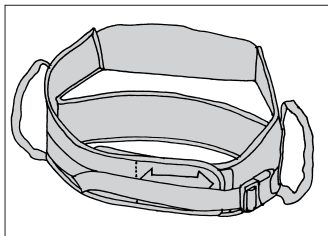

HeelStrap



SupportStraps

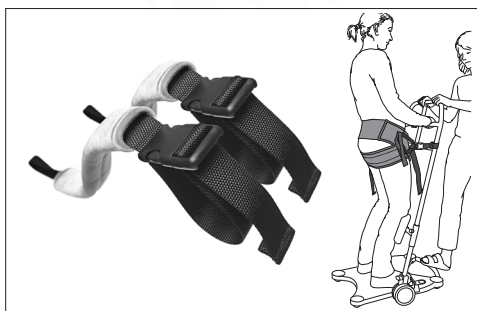

Padding for leg support



Simple solutions for great results

SystemRoMedic™ is the name of Handicare's unique easy transfer concept, the market's widest and most comprehensive range of clever, easy-to-use and safe transfer and lifting aids designed to make life easier, both for the user and for the caregiver. SystemRoMedic™ is a complete solution that provides for the majority of patient transfer or manual handling requirements. From the simplest to the most complex scenarios, from the lightest to the heaviest. The concept encompasses assistive devices for four different categories of transfers:

- Transfer, assistive devices for manual transfers of users between two locations.
- Positioning, assistive devices for manual repositioning of users within the same location.
- Support, assistive devices for mobility support e.g., during sit-to-stand or gait training.
- Lifting, assistive devices for manual and mechanical lifting of users.

Improved work environment, improved quality of care and cost savings

The philosophy behind SystemRoMedic™ is focused on the prevention and reduction of occupational injuries while allowing users to experience a greater sense of independence and dignity. Through a unique combination of training and a complete range of efficient transfer aids, SystemRoMedic™ offers improvement of both work environment and quality of care and, at the same time, achieves significant cost savings.

Always make sure that you have the correct version of the manual

The most recent version of all manuals are available for downloading at/from our website; www.handicare.com.

For questions about the product and its use

Please contact your local Handicare and SystemRoMedic™ representative. A complete list of all our partners with their contact details can be found on our website; www.handicare.com.

Handicare offers solutions and support to increase the independence of disabled or elderly people as well as to improve the convenience of those who are caring for them.

The Handicare Group is one of the leading healthcare companies in Europe with its own manufacturing organizations and sales companies in Norway, Sweden, Denmark, Germany, the Netherlands, Great Britain, France, China, Canada and the USA. Handicare's products are also distributed by partners in more than 40 countries worldwide. Our wide range of high-quality products includes various manual and power wheelchairs, seating systems, scooters, a complete easy transfer system and other patient handling aids, stairlifts, car adaptations, rise and recline chairs, and bathing and toileting products.



Handicare AB
Maskinvägen 17
SE-972 54 Luleå, SWEDEN
Tel: +46 (0)8-557 62 200
Fax: +46 (0)8-557 62 299
E-mail: info@handicare.se
www.handicare.com