

RiseAtlas450T RiseAtlas625T

SystemRoMedic™



User manual - English

REF

50100058 (RiseAtlas450T)

50100060 (RiseAtlas625T)

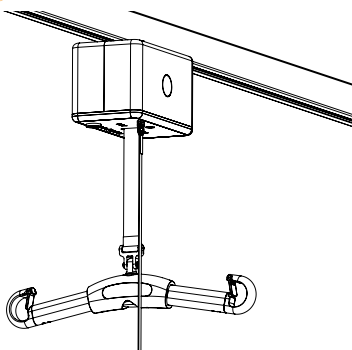

SWL:

RiseAtlas450T: 205 kg/450 lbs

RiseAtlas625T: 285 kg/625 lbs

RiseAtlas450T/625T is a safe and easy-to-use stationary ceiling lift unit which can be used in all settings and in all types of rooms, both on permanent rail systems and on portable, freestanding lift stands. When used with the appropriate lifting accessories, RiseAtlas450T/625T provides secure, comfortable and individually adapted lifting of users in connection with seated or horizontal transfers to and from the bed, wheelchair or toilet. RiseAtlas450T/625T offers a large lifting area and the possibility of both very low and very high lifting, making it an excellent solution also for lifting from the floor and for gait training and standing training. RiseAtlas450T/625T can also be used for convenient transfer of users from one room to another. RiseAtlas450T/625T is equipped with a built-in transfer motor.



Functional inspection

Visual inspection

Inspect lift functions regularly. Check to ensure that product is free from damage.

Before use

Ensure that the product is correctly mounted in the trolley.

Check rail end stops.

Check sling bar connection and safety latch function.

Check lifting movement.

Inspect the lift for signs of wear and damage.

Check the hand control cable for signs of wear.

Check to ensure that hand control markings coincide with lift functions.

Check battery charge level.



Always read the user manual

Always read the user manuals for all assistive devices used during a transfer.

Keep the user manual where it is accessible to users of the product.

Under no circumstances may the lift be used by persons who have not received instruction in the operation of the lift.

It is strongly prohibited to modify the original product.

Table of contents

Installation	3-9
- Unpacking and check	3
- Transport and storage	3
- Installing the lift unit	3-4
- Charging the lift unit	5-8
- Different rail systems	9
- Final inspection	9
Using the product	10-15
- Important information	10
- Before use	10
- Safe working load	11
- Description of functions and symbols	11
- Hand control	12
- Information panel	13
- Preventive service maintenance	13
- Emergency stop	14
- Electrical emergency lowering	14
- Manual emergency lowering/raising	14
- Trouble-shooting	15
Accessories	16
Maintenance	17
Technical information	18
- Detailed description	18

Installation

Unpacking and check

With RiseAtlas, the following is included in the package:

- 1 RiseAtlas lift unit
- 1 Hand control
- 2 Manuals - User manual, Assembly instructions for fuse
- 1 Charger station
- 1 Manual emergency lowering key

Check to ensure that no components are left in the packaging.
Inspect the lift unit for signs of damage.

Transport and storage

Before shipping, the fuse is removed to prevent battery discharge during transport or long-term storage.



Install the fuse in the lift unit according to the accompanying instructions.

Installing the lift unit

NOTE! The lift unit and carriage must be installed and inspected by authorized personnel according to instructions issued by Handicare AB. Periodic inspection must be performed at least once yearly. Use only original spare parts. Service and maintenance must be performed according to instructions in the user manual.

The lift must be charged for at least 3 hours before it is used for the first time. The lift unit is shipped with the fuse removed. Prior to installation the cover is removed and a 20A fuse is inserted. The fuse is packed in a bag. As standard, the lift is factory pre-set for charging at a charger station. When installing the lift unit for in-rail charging on the rail system, the system must be fitted with charger rails. Exercise caution when installing the lift unit, so that the charger wheels do not come in contact with the rail, since this may cause short-circuiting. Incorrect installation may cause short-circuiting and damage the charger.



Alteration of the charging method must be performed by authorized personnel according to instructions issued by Handicare AB.

Emergency Stop Strap

When the lift is correctly installed in the trolley system, the emergency stop strap needs to be adjusted. The emergency stop strap is cut at a height where the strap doesn't interfere with a normal lifting situation but at the same time is easily reached by all users.

The strap is cut with scissors and singed at the end as to prevent unravel.

Handicare recommends a height of 180 cm/70 inches above the floor.

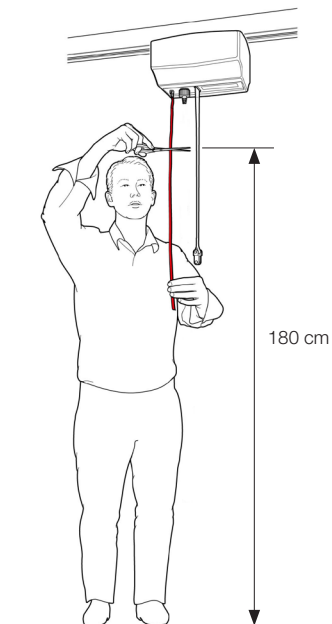

Assembly of charger unit

The following is included in the charger station package:

- Holder
- Charger cup

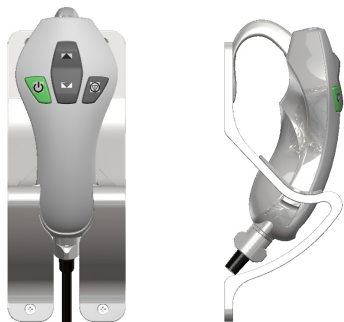

Charger cable (EU, UK, US connectors included)
(fixtures between charger station and wall/freestanding rail not included)

Charger station

- Secure holder to charger station on wall/freestanding rail system. Recommended height is 110-120 cm from floor.
- Mount the charger cable. If necessary mount the cover for the charger.
- Connect the accompanying hand control to the charger station and the hand control cable to the lift unit. Check charger function.

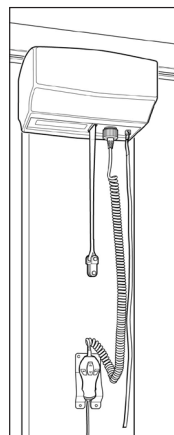

Charging the lift unit

RiseAtlas can be used with three different charging systems:

1. Charger station for charging via hand control (Standard)
2. In-rail charging (Accessory)
3. End-point charging (Accessory)

RiseAtlas is charged with a charger unit that is connected to the charger cables via a DC outlet. The charger should be kept in an appropriate location. Note that the charger is a separate unit and can be easily mistaken for another charger. Ensure that the correct charger is used, see Technical information. For assembly instructions, see Assembly of charger unit.

- 1) The lift unit is charged via a wall-mounted charger station. Place the hand control in the charger station. The charging lamp on the lift unit indicates charging for 15 minutes after being activated. Charging continues until the battery is fully charged.



- 2) For in-rail charging, the lift unit is always kept charged, which means that it can be left anywhere on the rail and will charge automatically.

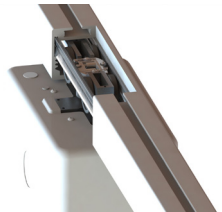

- 3) For end-point charging, the lift unit is placed at the charger station at the end of the rail. If the rail system is of the traverse type, the secondary rail is placed at the end of the primary rail at which the charger station is located. Check to ensure that the battery symbol on the lift unit lights up.

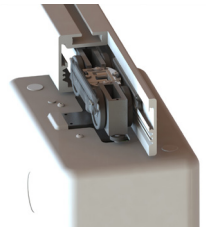

Alternative 2: In-rail charging (Accessory)

If the in-rail charging option is chosen, the lift unit must be fitted with a charger contact (70200062) and charger rails before installation. The charger that is included with the lift unit is used.



Alteration of the charging method must be performed by authorized personnel according to instructions issued by Handicare AB.

- 1) Set the charging points for in-rail charging; the charger plate is not secured with the spring pins, see figure 1. To set the charging points for in-rail charging, remove the spring pins that hold the charger plate in place. Then, the dip switch on the circuit board is set for the desired charging function.
- 2) Check to ensure that the charger plate springs in and out when pressure is applied to the charger plate, see figure 2.
- 3) Check to ensure that charger rails have been installed (installation of charger rails is described in the installation manual for MilkyWay).
- 4) Guide the lift unit onto the rail so that the plus on the charging point is on the right side, according to figure 3.
- 5) Connect the red cable to the charger rail on the right side, the charger plate's plus side (positive), and the black cable on the left side (negative), according to figure 4.
- 6) Install the end-stop on the rail.

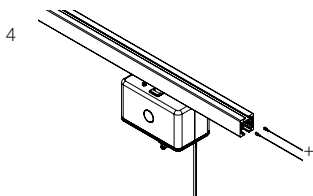
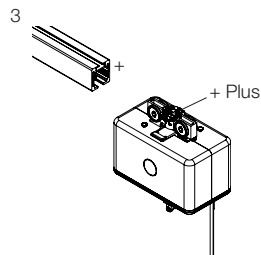
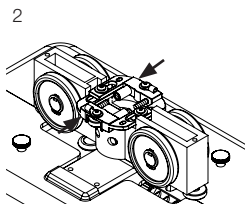
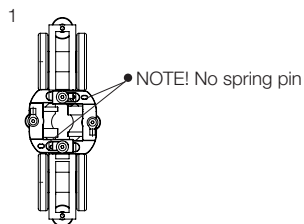

Alternative 3: End-point charging (Accessory)

If the end-point charging option is chosen, the lift unit must be fitted with a charger contact (70200062). The charger that is included with the lift unit is used.

- 1) Check to ensure that the charging points are set for the charger station; the charger plate is secured with the spring pins, see figure 1.
- 2) Check to ensure that the charger plate springs in and out when pressure is applied to the charger plate, see figure 2.
- 3) Guide the lift unit onto the rail so that the plus on the charging point is on the right side, according to figure 3.
- 4) Mount charger contacts according to figure 4. NOTE! Push the charger contact (A) in about 50 mm if only a stop bolt is used. When an adjustable end-stop is used, the charger contact is pushed in about 90 mm.
- 5) Affix the accompanying screws for charger contacts, see figure 5 (B).
- 6) Connect the red cable to the charger contact on the right side, the charger plate's plus side (positive), and the black cable on the left side (negative), according to figure 6.
- 7) Install the end-stop on the rail.

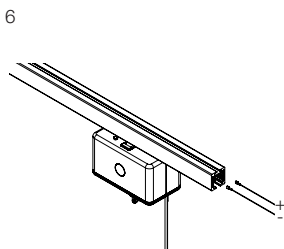
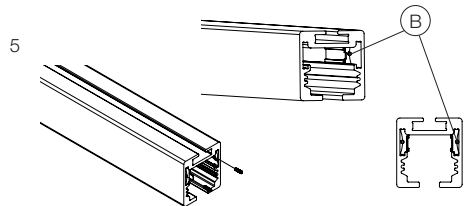
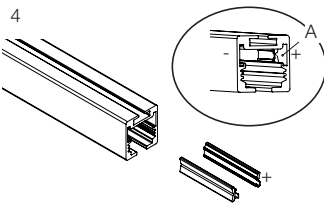
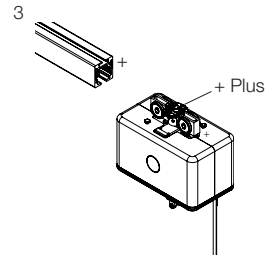
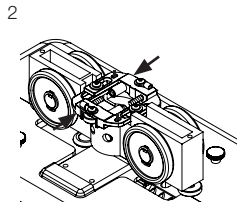
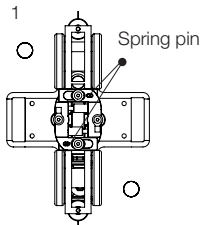

Battery status, charger station

- The battery symbol lights green when battery capacity exceeds 50 %.
- If the battery symbol blinks orange when the lift unit is started, the battery needs to be charged.
- If the battery symbol lights orange and a beep is heard when the lift unit is run up, the battery needs to be charged immediately.
- When the lift unit is started the battery symbol lights up for 2 seconds to indicate the current battery status.
- Six seconds after every operation the battery symbol lights for 2 seconds to indicate the current battery status. Only hand control charging or end point charging mode.



Charging indication (hand control charging and end point charging)

When the hand control is placed in the charger station 2 beep sounds are heard and the green light should stay on for 15 minutes.

Battery status, in-rail charging

The battery symbol lights green when battery capacity exceeds 50%.

When the lift unit is activated the battery symbol lights green for 15 minutes.

If the battery symbol and the book symbol blink orange when the lift unit is started, the circuit for the charging system has been broken and must be checked by a technician.

Active charging detection (In-rail charging)

After activation the lift unit will light the battery symbol for 15 minutes and after 4 minutes the charger should turn on. If the lift unit is missing the charger it will start indicate after 4 minutes. Green 15 minutes after activation.

NOTE!

Use only the charger that is intended for the lift unit.

For maximum service life, charge batteries regularly. Do not allow the battery charge level to fall below 25% (orange symbol on control panel).

Emergency stop must not be activated during charging.



Batteries may only be replaced by authorized personnel.

Different rail systems

The choice of rail system is determined by the lifting needs at hand.

Rail system with full room coverage, above bathroom wall

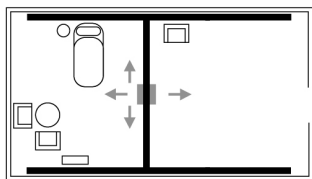

Basic rail systems, with curves and turn table

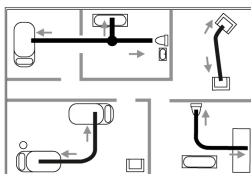

Freestanding lift stand



Final inspection

- The RiseAtlas lifting unit must be installed and first-time inspected by authorized personnel (inspector) in accordance with the installation instructions provided by Handicare AB. Periodic inspection of the equipment should be undertaken at least once a year. Original spare parts should be used and service/maintenance of the equipment should be in accordance with the user manual.
- Check to ensure that no parts have been left in the packaging.
- Check to ensure that the lift has no signs of damage from transportation.
- Check to ensure that the emergency stop is functioning by pulling the emergency stop strap, and then pressing the UP or DOWN button. If nothing happens, the emergency stop is working properly.
- Check the entire length of the strap for signs of damage and inspect seams for wear. Press the up button and run the strap all the way up. Then, press the down button and run the strap all the way down.
- Test lift function by lifting a person (not a user) using an approved lifting sling. At the same time, check both the user manual and electrical emergency lowering function with someone in the lift. See section on Emergency lowering.
- Check to ensure that the rail system is equipped with end stops.
- Check the hand control cable for signs of wear.
- Check to ensure that hand control markings coincide with lift functions.
- The user/attendant shall always pay attention to and report any unusual noises or vibration of the equipment.

NOTE!

Before the lift is used for the first time it must be charged for at least 3 hours. See section on charging the lift. RiseAtlas is shipped with the emergency stop activated to prevent battery discharge during transport or long-term storage.

Always keep the key for the emergency lowering close to the lift.

All personnel who use the lift must be informed of where the key is kept.

Using the product

Important information

- The user/attendant shall be trained professional with thorough understanding of the equipment and lifting of disabled persons. It is important that proper accessories and techniques are used by the user/attendant and it is also very important that a user never is left unattended in a lifting situation.
- Warranty does only apply if repairs or alterations are made to the lift by personnel who are authorized.
- RiseAtlas must not come in direct contact with water.
- RiseAtlas must not be charged in a wet room.
- To ensure optimal function, the lift must be inspected regularly. See section on Maintenance.
- Under no circumstances may safe working load be exceeded. See section on Technical information and the product label on the lift.
- Lifting accessories must be properly fitted and tested in relation to the user's needs and functional ability.
- Particular care must be taken when using the equipment near strong sources of interference, such as diathermy apparatus, so that e.g., diathermy cables and similar equipment are not placed near the device. When in doubt, consult your equipment technician or the supplier.

Before use









- Ensure that the product is correctly mounted in the trolley.
- Check rail end stops.
- Check sling bar connection and safety latch function.
- Check lifting movement.
- Inspect the lift for signs of wear and damage.
- Check the hand control cable for signs of wear.
- Check to ensure that hand control markings coincide with lift functions.
- Check battery charge level.

Safe working load







Different products on the same lift system (lift unit, sling and other lifting accessories) may have different allowable safe working loads. The lowest allowable safe working load always determines the safe working load of the assembled system. Always check the safe working loads for the lift and accessories before use. Contact your dealer if you have any questions.

Description of functions and symbols

RiseAtlas has many built-in functions. Each function is described in the respective section in the user manual, or in the user manual for the respective accessory. Below is a brief description of the functions that are available for caregivers and users.

	Read user manual		May not be discarded in domestic waste
	Medical Device Class I. The product complies with the requirements of the Medical Devices Directive 93/42/EEC.		Type B, according to the degree of protection against electric shock.
	The device is intended for indoor use.		Class II equipment
	Conforms to ISO 10535:2006 with ANSI/AAMI ES 60601-1:2005 and is certified to ISO 10535:2006 with CSA-C22.2 No. 60601-1:08		Always Read The User manual

Symbols on the product

	Battery status		Emergency stop
	The lift requires service or maintenance		Directional indication, transfer motor
	Overload		Warning! Read the user manual
	Read user manual		

Hand control

Connection of hand control to lift unit

The outlet for the hand control is under if the lift unit, fig 1. Connect the hand control firmly.

Raising/lowering

The buttons with the black arrows raise and lower the lift strap. Raising/lowering is interrupted as soon as pressure on the buttons is released, fig 2. The lift unit can also be activated with the buttons for raising/lowering.

ON/OFF via hand control

The hand control is equipped with a green button (ON) to activate the lift unit and a button (OFF) to shut it off (3). The lift unit automatically shuts off after 15 minutes of inactivity. Normally, the lift can be activated via the green (ON) button before use.

Night light

RiseAtlas is equipped with night lighting, which will be activated by pressing and holding the ON button on the hand control for 3 seconds. The LED lamp lights for 15 minutes if it is not inactivated via the OFF button on the hand control.

Activate/start the lift unit

The lift unit is activated by pressing the green button (ON) or the Up- or Down-button on the hand control. When this is done the battery symbol on the lift unit's information display is lit for 2 seconds, showing the current battery status. If the battery symbol does not light and the lift unit is not activated, check that the emergency stop is not activated (pulled out).

Active safety

RiseAtlas has a built-in slack strap switch requiring that, in order to be manoeuvred up or down, RiseAtlas must be loaded with at least 2 kg or its own weight. This is a safety feature that prevents a slack lift strap from being winded in or out from the lift unit causing a short fall when next in use.

RiseAtlas automatically stops if the lift strap is unloaded, for example if it is lowered onto a table.e.g., when the sling bar is lowered to a bed. If this happens, the lift strap must be manually stretched in order to be manoeuvred up or down.

If the lift strap is twisted when lifting upwards, the lift unit automatically stops and can only be manoeuvred down. In order to save battery the lift unit automatically turns off after 15 minutes of inactivity.

Tension release

When the top limit switch has been activated it will reverse the strap 5 mm to clear the pressure from the switch. This action will take place after the up button has been deactivated.

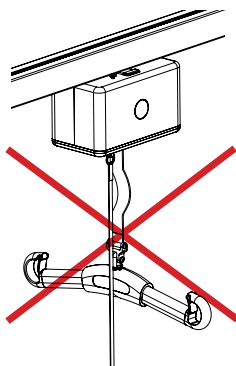
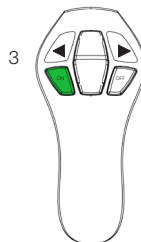
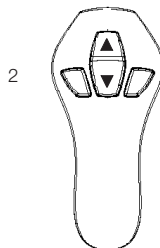
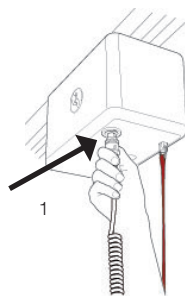

Information panel

On the control panel at the bottom of the lift unit there are several symbols. The symbols lights up when a function is activated. More information on each function is given below, and under chapter Trouble-shooting.

Battery status

Battery status is indicated after 6 seconds when a lift unit with end point charging is activated, and for 15 minutes if the in-rail charging option is used.



Service/maintenance

Information concerning service and maintenance. This symbol is activated once the lift unit has been used for 12 months.



Overload protection

RiseAtlas is equipped with overload protection, which prevents the lift unit from lifting more than the maximum rated load if this happen. A symbol for overload and a warning triangle light up and a signal is heard. If this symbol is activated, the user is too heavy.



Read user manual

Often, the book symbol will light up at the same time as another symbol lights up, indicating that the user should read the user manual before using the lift unit again.



Night light

RiseAtlas is equipped with night lighting, which will be activated by pressing and holding the ON button on the hand control for 3 seconds. The LED lamp lights for 15 minutes if it is not inactivated via the OFF button on the hand control.



Warning

The warning triangle is activated, prompting the user to read the user manual. Often, the warning triangle will light up at the same time as another symbol lights up, indicating that the user should read the user manual before using the lift unit again. Normally, a technician must be contacted when this symbol is activated.



Preventative service/maintenance

The symbol for service/maintenance lights up automatically when the lift unit has been used for 12 months. Contact an authorized Handicare service technician for maintenance and resetting.

Emergency stop

To activate emergency stop funktion: Pull the red emergency stop strap firmly, fig 1, and then release.

To reset: Push the plastic button that holds the red strap in place upward until it clicks, see fig 2.

When the emergency stop funktion is activated, a red indication is visible, fig 1, above emergency stop strap and its white plastic button.

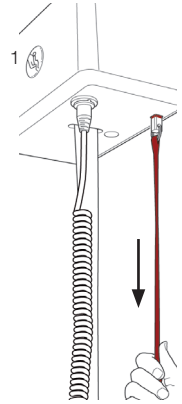

If the emergency stop strap is held down constantly, electrical emergency lowering will be activated. When the strap is released, the lift will stop.

Electrical emergency lowering

If the hand control is not functioning, electrical emergency lowering can be activated by holding the emergency stop strap down, fig 1. Lower the user to a safe height and location.



Electrical emergency lowering may only be used if the hand control is malfunctioning.

The electrical emergency lowering device feeds out the lift strap for as long as the emergency stop strap is held down. Ensure that the lowering motion is activated. Otherwise, electrical emergency lowering must be stopped. Always ensure that emergency lowering is done in an appropriate location.

To reset: Press the plastic button that holds the red strap in place upward until it clicks, see fig 2.

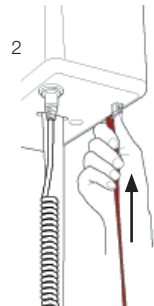

Manual emergency lowering/raising

Remove the plastic cover on the same side as the emergency stop strap, fig 3. On the inside of the cover there is an Allen key. Place the supplied Allen key in the hole as indicated, fig 4. Turn it counter-clockwise to lower and clockwise to raise the sling bar. Always ensure that emergency lowering is done in an appropriate location.

NOTE! Lowering is very slow.

Re-setting manual emergency lowering/raising: Contact an authorized Handicare service technician. Do not use the lift unit.

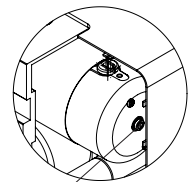
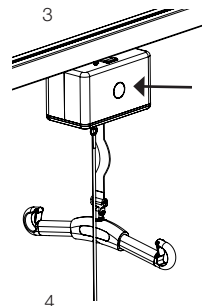

Allen key

Trouble-shooting

If lifting motion cannot be activated, check to ensure:

- that the emergency stop is not activated; on certain models, the emergency stop symbol lights up;
- that the lift unit is switched on (ON) via the hand control (a signal is heard);
- that the hand control is properly connected and pressed in securely; disconnect, and then replace it and press it in securely;
- that the lift unit is not in the charging position; the lift unit is blocked for use when it is in the charging position;
- that the battery is charged;
- that the charger has a power supply; the charging lamp on the charger unit should light up when the lift unit is placed in the charging position;
- that load is applied to the lift strap.

If the lift unit is not working properly, contact your Handicare dealer.

If the lift cannot be run all the way up to stop, check to ensure:

- that the overload symbol is not activated;
- that the battery symbol does not indicate low battery charge level.

If the lift cannot be run down, check to ensure:

- that load is applied to the lift strap;
- that the battery symbol does not indicate low battery charge level;
- that the directional indicators on the buttons, arrow up and arrow down, are correct.

If unusual sounds are heard:

- try to locate the source of the sound. Take the lift unit out of service and contact your Handicare dealer.

Symbol indication



The symbol indicates that the lift unit must be inspected. Contact your dealer.
The symbol lights up after 6-12 months.



Indicates battery charge status.



Emergency lowering battery

- Light up when accessory with 9V battery are connected and the power in the 9v battery is low (need to be changed). Both symbols will light amber. Sound should indicate (pip) every minute.



In-rail charging

- When book symbol light and the battery symbol flashes the charging function is not functioning. No contact with the charger.



Overload protection

- Prevents the lift from lifting more than the maximum load. If this happens A symbol for overload and a warning triangle light up (amber) a signal is heard. If this symbol is activated, the user is too heavy.

Accessories

QuickTrolley625, article no.: 70200063

QuickTrolley625-90, article no.: 70200064

Cover to charger, article no.: 50400066

In-rail/end point charging, article no.: 70200062

IR remote controlling, article no.: 70200065

9V battery and cable, article no.: 70200047

Software for diagnostics, article no.: 70200048

Parking Placard, article no.: 50400048



Lifting slings

Handicare's SystemRoMedic™ line includes a wide range of functional and comfortable, high-quality lifting slings that are adapted for all types of lifting and for users with different needs. The lifting slings are available in several materials and in sizes ranging from XXS to XXL. There are also special lifting sling models in XXXL and XXXXL for extremely large and heavy users. All models are safe and very easy to use.



Sling bars

SlingBar is a two-point aluminium sling bar available in three variants with different width. All variants of SlingBar have safety latches which prevent the sling straps from creeping out of the sling bar and all variants are for users weighing up to 300 kg/660 lbs.

To get more room in a lifting sling when using SlingBar two-point sling bar, SlingBarSpreader M side bars can be used as an accessory. SlingBarSpreader M open up the lifting sling and provide for a more reclined position.

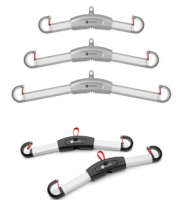

SlingBar XS, (250 mm) article no.:70200071

SlingBar S, (350 mm) article no.: 70200001

SlingBar M, (450 mm) article no.: 70200002

SlingBar L, (600 mm) article no.: 70200003

SlingBarSpreader M, article no.: 70200042

BariBar, article no.: 70200072

StretcherBar, article no.: 70200006, and StretcherSling, article no.: 46502007, for lifting in a supine position.

Sling bar RFL X4, four-point sling bar, Article no.: 70200017

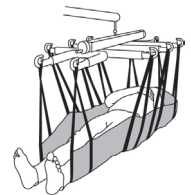

Scales

Handicare's SystemRoMedic™ scales Charder MHS2500 are used together with stationary or mobile lifts for weighing of users.

Article no.: 70100002 (300 kg/661 lbs)

Article no.: 70100003 (400 kg/881 lbs)



Assistive devices for positioning

Handicare's SystemRoMedic™ line includes a wide range of functional, comfortable, high-quality assistive devices for positioning that can be adapted for different types of lifting and for users with different needs.

Maintenance

The lift must undergo thorough inspection at least once per year. Inspection must be performed by authorized personnel and in accordance with Handicare's service manual.

Repairs and maintenance may only be done by authorized personnel using original spare parts.



Spent batteries are to be left at the nearest recycling station. Spent batteries can also be returned to Handicare or a Handicare dealer for recycling.

Cleaning/disinfection

If necessary, clean the lift with warm water or a soap solution and check that the castors are free from dirt and hair. Do not use cleaning agents containing phenol or chlorine, as this could damage the aluminium and the plastic materials. If disinfection is needed, 70 % ethanol, 45 % isopropanol or similar should be used.

Storage and transportation

If the lift is not to be used for some time or e.g., during transport, we recommend that the emergency stop button be pressed in. The lift should be transported and stored in -10 ° C to + 50 ° C and in normal humidity, 30% -75 %. The air pressure should be between 700 and 1060 hPa. Let the lift reach room temperature before the batteries are charged or the lift is used.

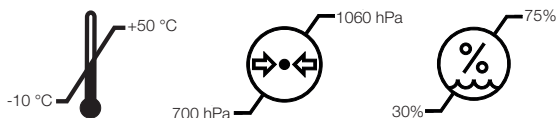

Service agreements

Handicare offers service agreements for maintenance and regular testing of your lift unit. Contact your local Handicare representative.

Serial number



Technical information

Lifting speed:	3,9 cm/s (5,0 cm/s), 1.5 inch/s (2.0 imch/s) with (without) load
Batteries:	24 VDC (20st 1,2VDC) 3,2 Ah. NIMH20XA3200
Charger IN:	Mascot 2215 100-240VAC/ 50-60Hz Max 0,9A.
Charger OUT:	41 VDC/ ±0,3 Max 0,9A
Lift motor:	24 VDC
Motor cover:	Flame-resistant ABS plastic
Sound level:	Unload: 55 dB; Max load: 57 dB
Hand control:	Electronic
Emergency lowering:	Manual and electrical
Lifting range:	2400 mm/95 inch
Lift weight:	7,5 kg, 16.5 lbs
IP class, lift unit:	IP 20
IP class, hand control:	IP X4
Lift measurements:	266 x 151 x 156 mm, 10.5" x 5.9" x 6.1"
Intermittent operation:	Op 10/90, active op. max. 2 min. Out of a time of 100, active time must be less than 10, though not more than 2 min.
Expected service life:	10 years
Pressure hand control:	4 N
SWL RiseAtlas450T:	205 kg, 450 lbs
SWL RiseAtlas625T:	285 kg, 625 lbs

Medical Device Class I. The product complies with the requirements of the Medical Devices Directive 93/42/EEC.

Detailed description

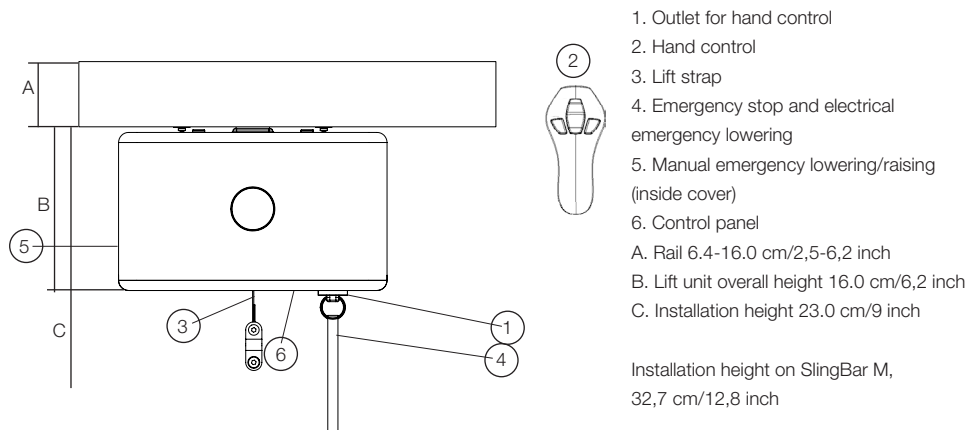

Simple solutions for great results

SystemRoMedic™ is the name of Handicare's unique easy transfer concept, the market's widest and most comprehensive range of clever, easy-to-use and safe transfer and lifting aids designed to make life easier, both for the user and for the caregiver. SystemRoMedic™ is a complete solution that provides for the majority of patient transfer or manual handling requirements. From the simplest to the most complex scenarios, from the lightest to the heaviest. The concept encompasses assistive devices for four different categories of transfers:

- Transfer, assistive devices for manual transfers of users between two locations.
- Positioning, assistive devices for manual repositioning of users within the same location.
- Support, assistive devices for mobility support e.g., during sit-to-stand or gait training.
- Lifting, assistive devices for manual and mechanical lifting of users.

Improved work environment, improved quality of care and cost savings

The philosophy behind SystemRoMedic™ is focused on the prevention and reduction of occupational injuries while allowing users to experience a greater sense of independence and dignity. Through a unique combination of training and a complete range of efficient transfer aids, SystemRoMedic™ offers improvement of both work environment and quality of care and, at the same time, achieves significant cost savings.

Always make sure that you have the correct version of the manual

The most recent version of all manuals are available for downloading at/from our website; www.handicare.com.

For questions about the product and its use

Please contact your local Handicare and SystemRoMedic™ representative. A complete list of all our partners with their contact details can be found on our website; www.handicare.com.

Handicare offers solutions and support to increase the independence of disabled or elderly people as well as to improve the convenience of those who are caring for them.

The Handicare Group is one of the leading healthcare companies in Europe with its own manufacturing organizations and sales companies in Norway, Sweden, Denmark, Germany, the Netherlands, Great Britain, France, China, Canada and the USA. Handicare's products are also distributed by partners in more than 40 countries worldwide. Our wide range of high-quality products includes various manual and power wheelchairs, seating systems, scooters, a complete easy transfer system and other patient handling aids, stairlifts, car adaptations, rise and recline chairs, and bathing and toileting products.



Handicare AB
Maskinvägen 17
SE-972 54 Luleå, SWEDEN
Tel: +46 (0)8-557 62 200
Fax: +46 (0)8-557 62 299
E-mail: info@handicare.se
www.handicare.com