

REF 6080001
StandUp with power cable

REF 6080002
StandUp, with battery

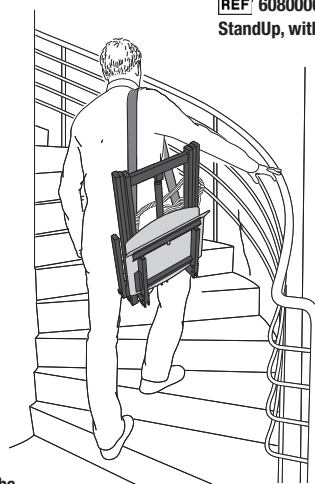

SWL: 160 kg/ 352 lbs

StandUp is a lifting chair that has been designed to assist patients up from the floor to a seated or standing position if they have fallen. It is only intended for patients who are not seriously injured and can manage on their own once they have been lifted from the floor. StandUp is foldable and is equipped with a carrier strap for easy transport.

Handicare's SystemRoMedic product series includes a range of lifts, slings and other accessories. SystemRoMedic adopts a holistic approach to patient transfers and is organized in four categories: transfer, positioning, support and lifting.



Functional inspection

Visual inspection

Inspect the lifting chair functions regularly. Check to ensure that material is free from damage.

Before use

Ensure that the product is correctly assembled.



Always read the manual

Always read the manuals for all assistive devices used during a transfer.

Keep the manual where it is accessible to users of the product.

The lifting chair may only be used by persons who have received instruction in the operation of the lifting chair.

Assembling StandUp

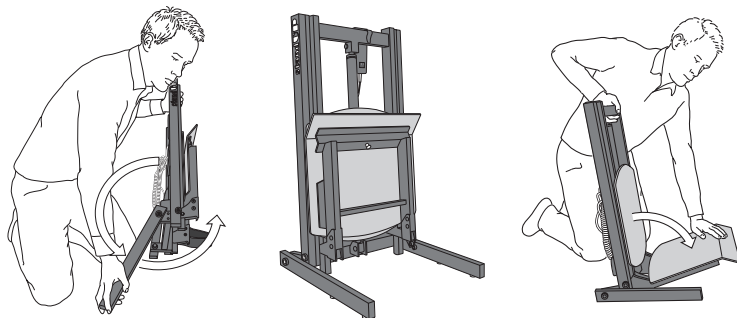

Fold out the two legs and twist them $3/4$ of a turn, so that they are facing forward and the back section is stable.

Fold down the seat.

StandUp with power cable: Plug the power cable into a wall socket.

StandUp is now ready for use. Run the seat section up and down once to ensure that everything is working correctly.

Disassembling StandUp

StandUp with power cable: Coil the power cable and secure it to the back of StandUp.

Fold the seat up.

Twist the two legs back $3/4$ of a turn.

Final inspection

Check to ensure that no parts have been left in the packaging.

Inspect the lifting chair for signs of wear and damage.

Check all connections and fixtures including screws and bolts.

Ensure that the product is correctly assembled.

Grasp the handset, press the Up button and run the lifting chair all the way up. Then, press the Down button and run the lifting chair all the way down.

Test lifting chair function by lifting a person (not a patient).

NOTE!

Keep the manual where it is accessible to users of the product.

Using the product

Important information

- The lifting chair must be assembled according to the assembly instructions provided with the lifting chair.
- The lifting chair may only be used indoors and on a level floor.
- The lifting chair should never be used without the legs are unfolded.
- Lifting accessories must be properly fitted and tested in relation to the patient's needs and functional ability.
- Do not leave the patient unattended during a transfer situation.
- Under no circumstances may max. load be exceeded. See section on max. load.
- The lifting chair must not come in direct contact with water.
- To ensure optimal function, the lifting chair must be inspected regularly. See section on maintenance.
- Warranty applies only if repairs or alterations are done by an authorized technician.

Charging batteries (StandUp with battery)

Charge the lift after use to ensure that the battery is always fully charged.

Connect the charging cable to a power outlet.

The yellow LED lamp indicates that the battery is charging.

Charging stops automatically when the battery is fully charged.

NOTE!

Before the lift is used for the first time, it must be charged for at least 4 hours.

For maximum battery life, charge batteries regularly. We recommend daily charging when the lift is used daily.

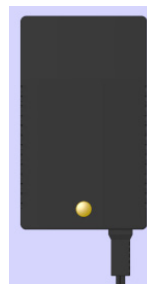

Handset

Raising/lowering

Markings on the buttons indicate function.

Motion stops as soon as the button is released.

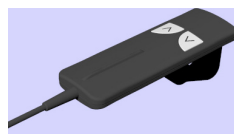

Using

StandUp provides a convenient means of assisting a patient who has fallen to the floor. Before use, ensure that the patient has not sustained any serious injury.

Assemble StandUp according to the directions on page 2.

Help the patient to a seated position and place the patient's feet on an AntiSlip. Then, place StandUp behind the patient's back and help the patient to move to the seat. This can be done in two ways:

1. Place the SitWalk under the patient's seat and pull the patient onto the StandUp seat. Ask the patient to assist by applying counter pressure, if possible.
2. Place the SitWalk under the patient's seat and help the patient to "sit-walk" onto the StandUp seat. Ask the patient to assist by applying counter pressure, if possible.

Always work in a walking stance, with knees slightly bent, and back and arms straight. Use weight transfer for best work technique.

Once the patient is sitting on the StandUp seat, use the handcontrol to raise the patient from the floor. Encourage the patient to participate, if possible, by applying counter pressure and manoeuvring himself/herself into a seated position. For safety and security, always remain close to the patient during the raising operation. When the patient has reached full sitting height, help the patient to stand or transfer to a chair or bed.

StandUp can now be folded up again for convenient storage or transport.

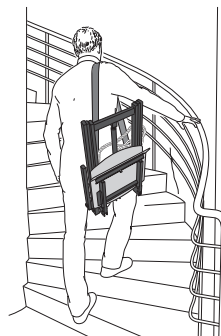
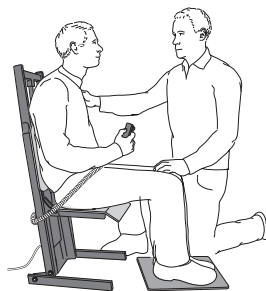
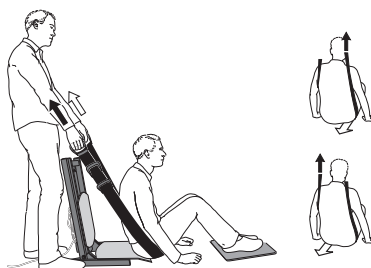
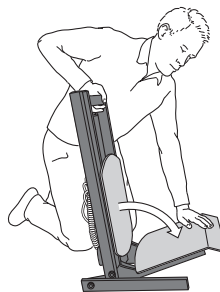

Accessories

SitWalk

A strap with handles that is placed under the patient' s seat to assist the patient onto the StandUp. 245 x 12 cm



REF: 6085

SpaciousBag

A transport and storage bag, with wheels on one side, for StandUp and accessories. Adjustable handles can be adapted for use as shoulder straps.



REF: 00951

AntiSlip

A friction mat that is placed under the patient's feet for better traction. 45 x 38 cm.



REF: 8040

EasySlide/ReadySlide

A slide mat that is placed under a heavy patient's seat so as to reduce friction when assisting the patient onto the StandUp.

EasySlide: 50 x 60 cm (Art. no 2010, 2020)

EasySlide: 50 x 70 cm (Art. no 2011, 2021)

ReadySlide: 70 x 70 cm (Art. no 11250)



EasySlide: 50 x 60 cm, REF: 2010, 2020

EasySlide: 50 x 70 cm, REF: 2011, 2021

ReadySlide: 70 x 70 cm, REF: 11250

Maintenance

The lift must undergo thorough inspection at least once per year. Inspection must be performed by authorized personnel and in accordance with Handicare's service manual.

Repairs and maintenance may only be done by authorized personnel using original spare parts.

Disposal

StandUp can be separated into metal, plastic and electronic parts for recycling and disposal.

Cleaning and disinfection

When necessary, clean the lifting chair with warm water or rubbing alcohol. Do not use cleaning agents containing phenol or chlorine.

Dimensions



	Cm	Inch
A	74-114	29-45
B	45	17.7
C	44	17.3
D	43	16.9
E	5-44	2-17.3
F	39.5	15.6
G	19	7.5

Technical information with power cable

Lifting speed:	7.6 mm/s without load
Input:	230V AC/50Hz/180VA int.10% max. 2/18 min.
Motor:	DC 24V, 4.5 A. IP51.
Operating time:	10% maximum continuous in 2/18 minutes. Push: 6000N.
Sound level:	Noise level 48dB (A); measuring method DS/EN ISO 3746, actuator not loaded.
Material:	Aluminium
IP class:	IPX4.
Weight:	11.5 kg
Expected service life:	10 years
SWL:	160 kg/352 lbs



The device is intended for indoor use.



Type B, according to the degree of protection against electric shock.

The product complies with requirements for medical devices directive 93/42/EEG.

Technical information with battery

Lifting speed:	7.6 mm/s without load
Input:	230V AC/50Hz/180VA int.10% max. 2/18 min.
Motor:	DC 24V, 4.5 A. IP51.
Operating time:	10% maximum continuous in 2/18 minutes. Push: 6000N.
Sound level:	Noise level 48dB (A); measuring method DS/EN ISO 3746, actuator not loaded.
Material:	Aluminium
IP class:	IPX4.
Weight:	11.5 kg
Expected service life:	10 years
SWL:	160 kg/352 lbs



The device is intended for indoor use.



Type B, according to the degree of protection against electric shock.

The product complies with requirements for medical devices directive 93/42/EEG.

SystemRoMedic™

For 25 years we have applied ourselves wholeheartedly to developing smart and easy-to-use assistive devices for easy transfers and to making life and work easier for both patients and personnel in the care sector.

Experience, innovation and training are the basis for SystemRoMedic, a total solution for every imaginable transfer situation.

Transfer: products for moving patients between locations.

Positioning: products for repositioning in the same location.

Support: products that provide mobility support.

Lifting: products adapted for lifting.

The philosophy behind SystemRoMedic is to prevent occupational injuries while improving the patient's sense of independence and dignity. Through a combination of training and a complete range of transfer-assistive devices, SystemRoMedic offers the means to improving both the work environment and the quality of care while enabling significant cost savings.

Our mission, to help people, has always been, and will continue to be, the driving force of innovation. We love easy transfers.

Contact your local distributor if you have any questions about the product and its use. See www.handicare.com for a complete list of distributors. Always make sure that you have the right version of the manual. The most recent editions of manuals are available for downloading from our website, www.handicare.com.



handicare

Handicare AB
Veddestav. 15, Box 640
SE-175 27 Järfälla
SWEDEN

Tel: +46 (0)8-557 62 200
Fax: +46 (0)8-557 62 299
E-mail: info@handicare.se

Internet: www.handicare.com